

2000-04-26

# The Exploration of Tissue pH and its Relationship to Bacterial Contamination

Susan M. Shorrock  
*Worcester Polytechnic Institute*

Follow this and additional works at: <https://digitalcommons.wpi.edu/etd-theses>

---

## Repository Citation

Shorrock, Susan M., "The Exploration of Tissue pH and its Relationship to Bacterial Contamination" (2000). *Masters Theses (All Theses, All Years)*. 319.

<https://digitalcommons.wpi.edu/etd-theses/319>

This thesis is brought to you for free and open access by Digital WPI. It has been accepted for inclusion in Masters Theses (All Theses, All Years) by an authorized administrator of Digital WPI. For more information, please contact [wpi-etd@wpi.edu](mailto:wpi-etd@wpi.edu).

**THE EXPLORATION OF TISSUE pH IN WOUNDS AND ITS  
RELATIONSHIP TO BACTERIAL CONTAMINATION**

by

Susan Margaret Shorrock

A Thesis

Submitted to the Faculty

of the

WORCESTER POLYTECHNIC INSTITUTE

in partial fulfillment of the requirements for the

Degree of Master of Science

in

Biomedical Engineering

May 2000

APPROVED:

Stevan Kun, Ph.D., Major Advisor  
Research Assistant Professor  
Biomedical Engineering Department, WPI

Dr. Raymond Dunn, Co-Advisor  
Interim Chief of Plastic Surgery  
UMASS Memorial Healthcare

Dr. Robert Peura, Co-Advisor  
Professor  
Biomedical Engineering Department, WPI

George Gumbrell, Co-Advisor  
Biomedical Engineer Consultant

## ABSTRACT

Presently, plastic surgeons do not have a methodology for non-invasive, real-time assessment of wound tissue properties. It is of extreme importance to objectively determine the health of wound tissue and the level of bacterial infection before surgical closure of the wound is attempted. Wounds that possess significant areas of low blood perfusion and high levels of bacteria will not be successfully grafted. Thus, this research aims at identifying and testing a measurable parameter for the assessment of tissue properties in acute and chronic wounds.

Tissue pH, which is easily measured, has been proven to detect the presence of tissue ischemia. In this research, the variations of tissue pH levels in patient wounds and the relationship between tissue pH and bacteria levels were explored. Micro-combination pH electrodes were tested; software algorithms for acquiring and processing raw tissue pH data were developed; and calibration, sterilization, animal, and clinical protocols were designed. Animal and clinical studies were performed.

Small variations in tissue pH values were found within patient wounds and between patient cases. A qualitative relationship between tissue pH levels and bacterial contamination was identified. As the bacterial contamination rises, the average tissue pH level tends to decrease. A methodology that clinicians can use to efficiently measure tissue pH in wounds was developed.

This research provides preliminary work in an area that has not been previously explored. It was shown that tissue pH measurements can be acquired efficiently, non-invasively, and with no discomfort to the patient. The incorporation of tissue pH measurements into the evaluation of wounds will contribute to providing an objective measure of the health of the tissue and aid plastic surgeons in the development of patient treatments.

## ACKNOWLEDGMENTS

Funding for this research was provided by the National Science Foundation. The pH electrodes used during this study were donated by Microelectrodes, Inc., Bedford, NH.

I would like to extend my gratitude to the staff of the Division of Plastic Surgery at UMASS Memorial Healthcare. Specifically, I would like to thank Robin Smith and Adam Lowenstein for spending many hours in Animal Medicine developing and testing the animal protocol. Thanks to Susan Longwell for always being supportive. A special thanks to Dr. Raymond Dunn who was the driving force behind this research. His dedication to the topic of using tissue pH measurements in clinical practice was inspiring. I learned a great deal from Dr. Dunn about medical practices and how to translate this research experience into lessons for life.

Thanks to George Gumbrell for his advice and interest in the project. Thanks to Ina Lemon for her dedication and continuous help during my stay at WPI. I would also like to acknowledge Dr. Robert Peura for his academic advise and support.

A special thanks to my parents and sisters for their support during my graduate studies. They have helped me to be confident in my work.

Finally, I would like to thank my major advisor, Dr. Stevan Kun. He has been my mentor during my studies here at WPI. He has taught me valuable lessons about conducting research and communicating my ideas to the world.

## TABLE OF CONTENTS

ABSTRACT.....	i
ACKNOWLEDGMENTS .....	ii
<b>1. PROBLEM IDENTIFICATION .....</b>	<b>1</b>
<b>2. AIMS.....</b>	<b>4</b>
<b>3. MAIN HYPOTHESES AND RESEARCH APPROACH .....</b>	<b>7</b>
3.1 HYPOTHESES .....	7
3.2 RESEARCH APPROACH.....	9
<b>4. BACKGROUND .....</b>	<b>14</b>
4.1 LITERATURE REVIEW STRATEGY .....	14
4.2 HISTORY OF WOUND MANAGEMENT .....	15
4.3 ECONOMICS OF CHRONIC WOUND CARE .....	16
4.4 PH THEORY AND MEASUREMENT .....	17
4.4.1 <i>Trends in Tissue pH Levels</i> .....	19
4.4.1.1 Physiological Basis of the Relationship between Bacteria and pH .....	20
4.4.2 <i>Analysis of pH Values</i> .....	21
4.5 CAUSES AND TYPES OF WOUNDS.....	21
4.5.1 <i>Acute Wounds</i> .....	21
4.5.2 <i>Chronic Wounds</i> .....	21
4.6 WOUND INFECTION .....	24
4.7 WOUND TREATMENT AND HEALING.....	26
4.8 GLOSSARY OF MEDICAL TERMINOLOGY .....	29
<b>5. HARDWARE AND SOFTWARE DESCRIPTION FOR PH ACQUISITION .....</b>	<b>31</b>
5.1 HARDWARE DESCRIPTION .....	31
5.1.1 <i>Hardware Operation</i> .....	31
5.2 SOFTWARE DESIGN.....	33
5.3 GRAPHICAL USER INTERFACE .....	33
5.3.1 <i>Patient Information</i> .....	35
5.3.2 <i>System Setup</i> .....	36
5.3.3 <i>pH-Calibration</i> .....	36
5.3.4 <i>View</i> .....	38
5.4 ALGORITHM DEVELOPMENT .....	40
5.4.1 <i>Calculation of pH</i> .....	40
5.4.2 <i>pH Stabilization Algorithm</i> .....	41
5.4.3 <i>Output File</i> .....	44
5.5 THE pH MONITORING SYSTEM .....	46
<b>6. METHODS AND PROTOCOLS .....</b>	<b>47</b>
6.1 TESTING OF THE MI-414 ELECTRODES .....	47
6.1.1 <i>Time Constant Determination</i> .....	48
6.1.1.1 Calibration Time Constant.....	48
6.1.1.2 Electrode Time Response .....	49
6.1.2 <i>Stability Tests</i> .....	49
6.1.2.1 Long Term Stability .....	50
6.1.2.2 Stability while Holding the Electrode .....	50
6.1.3 <i>Temperature Dependence Tests</i> .....	51
6.1.4 <i>Effects of Sterilization on Electrode Characteristics</i> .....	52
6.2 CALIBRATION OF ELECTRODES.....	52
6.2.1 <i>Calibration Procedure</i> .....	53

6.3	ANIMAL STUDIES.....	55
6.3.1	<i>Animal Studies Protocol</i> .....	55
6.3.1.1	Model One.....	56
6.3.1.2	Model Two .....	56
6.3.2	<i>Methods for Securing the Wound</i> .....	57
6.3.3	<i>Final Animal Model</i> .....	58
6.4	STERILIZATION PROTOCOL .....	59
6.5	CLINICAL STUDIES.....	60
6.6	DATA ANALYSIS.....	62
6.6.1	<i>Analysis of pH Signals</i> .....	62
6.6.2	<i>Analysis of Tissue pH Variations</i> .....	63
6.6.3	<i>Analysis of the Relationship between Tissue pH levels and Wound Properties</i> .....	64
<b>7.</b>	<b>RESULTS.....</b>	<b>66</b>
7.1	TESTING OF THE MI-414 ELECTRODES .....	66
7.1.1	<i>Results of Time Constant Determination</i> .....	66
7.1.1.1	Calibration Time Constant.....	66
7.1.1.2	Electrode Response Time .....	66
7.1.2	<i>Results of Stability Tests</i> .....	68
7.1.2.1	Long Term Stability.....	68
7.1.2.2	Stability while Holding the Electrode.....	68
7.1.3	<i>Results of Temperature Dependence Tests</i> .....	69
7.1.4	<i>Effects of Sterilization of the Electrodes</i> .....	69
7.2	CALIBRATION OF ELECTRODES.....	74
7.3	ANIMAL STUDIES RESULTS.....	76
7.3.1	<i>Cumulative Results of Animal Tests</i> .....	76
7.3.2	<i>Analysis of Relationship between Tissue pH Levels and Bacterial Contamination</i> .....	76
7.4	CLINICAL STUDY RESULTS.....	82
7.4.1	<i>Patient Information</i> .....	82
7.4.2	<i>Cumulative Results of Clinical Testing</i> .....	84
7.4.3	<i>Analysis of Relationship between Tissue pH Levels and Bacterial Contamination</i> .....	85
7.4.4	<i>Tissue pH Variations within the Wound</i> .....	86
<b>8.</b>	<b>DISCUSSION.....</b>	<b>99</b>
8.1	DISCUSSION OF TESTING OF THE MI-414 ELECTRODES .....	99
8.1.1	<i>Discussion of Time Constant Determination</i> .....	99
8.1.1.1	Discussion of Calibration Time Constant Results.....	99
8.1.1.2	Discussion of Electrode Response Time.....	100
8.1.2	<i>Discussion of Stability Tests</i> .....	101
8.1.2.1	Long Term Stability.....	101
8.1.2.2	Stability while Holding the Electrodes .....	101
8.1.3	<i>Discussion of Temperature Dependence Tests</i> .....	101
8.1.4	<i>Discussion of Effects of Sterilization</i> .....	102
8.2	CALIBRATION OF ELECTRODES.....	102
8.3	DISCUSSION OF ANIMAL STUDY RESULTS .....	102
8.3.1	<i>Discussion of Animal Models</i> .....	102
8.3.2	<i>Recommendation for a New Animal Model</i> .....	103
8.3.3	<i>Discussion of Cumulative Results</i> .....	104
8.3.4	<i>Discussion of Relationship between Tissue pH and Bacterial Levels</i> .....	104
8.4	DISCUSSION OF CLINICAL STUDY RESULTS .....	105
8.4.1	<i>Discussion of Cumulative Results</i> .....	105
8.4.2	<i>Discussion of Relationship between Tissue pH and Bacterial Levels</i> .....	106
8.4.3	<i>Discussion of Tissue pH Variations within the Wound</i> .....	108
8.4.4	<i>Indications for Clinicians for Taking Tissue pH Measurements</i> .....	109
<b>9.</b>	<b>CLINICAL SIGNIFICANCE.....</b>	<b>111</b>
9.1	MEDICAL STAFF REACTION .....	112

9.2 FUTURE APPLICATIONS .....	113
<b>10. CONCLUSIONS.....</b>	<b>114</b>
10.1 ACHIEVEMENT OF AIMS.....	114
10.2 CONCLUSIONS ON HYPOTHESES .....	115
<b>11. FUTURE WORK.....</b>	<b>119</b>
<b>12. BIBLIOGRAPHY.....</b>	<b>122</b>
<b>APPENDIX A.....</b>	<b>126</b>
<b>APPENDIX B.....</b>	<b>130</b>
<b>APPENDIX C.....</b>	<b>131</b>

## TABLE OF FIGURES

Figure 3.1: Flowchart of Research Approach .....	13
Figure 4.1: The MI-414-2cm electrode manufactured by Microelectrodes, Inc. ....	17
Figure 4.2: An example of a glass pH electrode .....	17
Figure 4.3: The physiology of normal wound healing and pathophysiology of chronic wounds .....	23
Figure 5.1: Block diagram of the hardware configuration of the system .....	32
Figure 5.2: Main window of the pH monitoring program .....	34
Figure 5.3: <i>Patient Information</i> menu option .....	35
Figure 5.4: Patient Information window .....	35
Figure 5.5: <i>System Setup</i> menu option .....	36
Figure 5.6: <i>pH-Calibration</i> menu option .....	36
Figure 5.7: First step in the two-point calibration process .....	37
Figure 5.8: Electrode Stabilization window used in the calibration process .....	37
Figure 5.9: <i>View</i> menu option .....	38
Figure 5.10: <i>pH Imaging</i> window .....	39
Figure 5.11: Stabilization notification window .....	40
Figure 5.12: Code that checks for stabilization of the tissue pH signal .....	42
Figure 5.13: Code that calculates an average for a pH signal that did not stabilize .....	44
Figure 5.14: Portions of an output file from pH acquisition software .....	45
Figure 6.1: Representation of the wound area and the locations of the pH measurements and tissue biopsies .....	57
Figure 7.1: Typical electrode stabilization recordings during calibration .....	70
Figure 7.2: Measured responses of the pH electrodes when switched between pH buffers .....	70
Figure 7.3: Results of a long-term electrode stability test .....	71
Figure 7.4: Typical results from testing for stability while holding the electrode .....	71
Figure 7.5: Recorded pH versus temperature for an electrode in a 7.0 pH buffer .....	72
Figure 7.6: More detailed graph of electrode response versus temperature (37 to 44 °C) .....	72
Figure 7.7: More detailed graph of electrode response versus temperature (33 to 36 °C) .....	73
Figure 7.8: Example calibration curve .....	75
Figure 7.9: Calibration characteristics at 37 °C and 21 °C .....	75
Figure 7.10: Preparation of a rat using model one and a wire mesh covering .....	79
Figure 7.11: Infected wound. Incubation time of 72 hours .....	79
Figure 7.12: Method of stapling rat's skin after inoculation .....	79
Figure 7.13: Infected wound using model two .....	79
Figure 7.14: Scatter plot of all the data points acquired during animal testing .....	80
Figure 7.15: Frequency histogram of all the animal study data .....	80
Figure 7.16: Differential tissue pH measurements versus bacteria levels for last four animal studies .....	81
Figure 7.17: Approximate relationship between tissue pH and bacteria counts (last three animal studies) .....	81
Figure 7.18: Patient 1001's left medial leg .....	87
Figure 7.19: Patient 1002's lateral right leg .....	87
Figure 7.20: Patient 1003's left anterior leg .....	88
Figure 7.21: Patient 1004's behind .....	88
Figure 7.22: Patient 1005's left lateral leg .....	89
Figure 7.23: Patient 1005's left medial leg .....	89
Figure 7.24: Patient 1005's right medial leg .....	90
Figure 7.25: Patient 1006's left lateral lower arm .....	90
Figure 7.26: Patient 1007's left medial thigh .....	91
Figure 7.27: Patient 1007's left medial lower leg .....	91
Figure 7.28: Patient 1008's right foot .....	92
Figure 7.29: Patient 1008's right foot .....	92
Figure 7.30: Patient 1009's left leg .....	93
Figure 7.31: Patient 1009's left knee .....	93
Figure 7.32: Patient 1010's right medial arm .....	94
Figure 7.33: Scatter plot of cumulative patient data .....	95



Figure 7.34: Frequency histogram of clinical data .....	95
Figure 7.35: Frequency histogram of patient data with a step size of 0.05 pH units. ....	96
Figure 7.36: Stratified plot of patient data .....	96
Figure 7.37: Plot of the average tissue pH levels from each patient versus qualitative measures of bacterial contamination .....	97
Figure 7.38: Contour plot of the tissue pH variations in patient 1010's wound .....	98
Figure 7.39: Contour plot of the tissue pH variations in patient 1006's wound .....	98

## TABLE OF TABLES

Table 4.1: Literature review categories and keyword searches .....	15
Table 4.2: Factors that impair wound healing.....	22
Table 6.1: Categories of rats and times of biopsies following inoculation .....	56
Table 7.1: Table of times needed for stabilization during calibration.....	67
Table 7.2: Data describing the response of the electrode to step changes in pH .....	67
Table 7.3: Summary of statistics of response time of electrode to changes in pH.....	68
Table 7.4: Electrode 64236 calibration characteristics before and after sterilization .....	69
Table 7.5: Calibration characteristics for MI-414 electrodes.....	74
Table 7.6: Overview of the methods used for each animal study .....	78
Table 7.7: Summary of patients' personal information .....	82
Table 7.8: Summary of wound information to provide background on wound status. ....	83
Table 7.9: Bacteria counts, average tissue pH level, standard deviation, and number of valid measurements from each patient.....	86

## 1. PROBLEM IDENTIFICATION

Both plastic/reconstructive surgeons and general practice physicians frequently encounter acute and chronic wounds in their treatment of patients. The cause of acute wounds is usually trauma such as stab wounds or accidents. The cause of chronic wounds may be infection or ischemia, which is a deficiency of oxygen and nutrient supply to the tissue due to constriction or obstruction of a blood vessel. The level of bacterial wound contamination is a vital indication of the status of the wound or the healing prognosis, yet clinicians can not easily assess this parameter. Currently, tissue cultures are used to determine bacterial levels, yet accurate results are not produced for several days, inhibiting a surgeon's decision concerning proper treatment. The bacterial contamination levels can not be instantaneously and objectively assessed resulting in a delayed determination of the cause and condition of the wound.

Presently, there is no methodology for non-invasive, real-time assessment of wound condition. If the cause of a wound's inability to heal is unknown, as in the case of many chronic wounds, surgeons use intuition and experience to assess the wound's properties. An objective estimation of the wound's condition is impossible without a measurable parameter which can afford information about the tissue and foreign substances present in the wound. As a result, it is difficult to accurately predict for what reason a wound's healing process is inadequate. It is crucial to understand the properties of a wound because the treatment of wounds varies radically from case to case.

Past researchers have hypothesized that a correlation exists between the level of bacteria present in a wound and the level of the wound's tissue pH [1,2]. Also, it is known that ischemia lowers the tissue pH [3,4,5]. If a chronic wound possesses vasculature degradation and perfusion reduction, the pH of the wound will fall. Taking into consideration the theory that a tissue's pH is correlated to its level of contamination and the fact that tissue pH falls upon the event of ischemia, pH may be an excellent parameter for objective characterization of chronic wounds. Thus far, the relationship between a tissue's pH and its properties has not been clarified. The use of such a relationship in determining the condition and cause of chronic wounds has not been explored. It is apparent that several issues must be examined before an accurate and objective measurement tool for the assessment of chronic wounds is realizable.

**Problem #1:** Studies have not been conducted on the variation of pH within a wound.

A real-time measurable parameter for the objective examination of chronic wounds has not been established. It has been hypothesized that tissue pH varies within the wound. This theory has not been thoroughly tested and its application to the determination of chronic wound properties has not been explored. To date, the tissue pH of chronic wounds has not been systematically analyzed. Additionally, patterns of variation of tissue pH within the wound are not presently understood, making the use of tissue pH as a parameter for wound assessment inappropriate without extensive research in this area.

**Problem #2:** In depth research on the correlation between bacterial contamination of chronic wounds and the level of tissue pH has not been performed.

It has been documented that tissue pH varies with varying levels of bacterial contamination. This theory has not been extensively tested and has not been applied specifically to chronic wounds. A concrete relationship between the bacterial count and the pH of tissue in a chronic wound has not been determined. Thus, it is not currently possible to evaluate if tissue pH can be used as a measurement tool for assessment of bacterial levels in chronic wounds.

**Problem #3:** Using tissue pH as a tool for determining properties of chronic wounds has not been explored.

Tissue pH is a common parameter used in diagnostics in the hospital, yet it has never been used as a measure of chronic wound properties. As a result, several issues arise. The safety and comfort of the patient is a top priority. In addition, effective methods for efficient calibration and sterilization of electrodes that are used to measure a wound's pH have not been developed. Thus, several factors involved in using pH as a measurement tool in chronic wound assessment have not been examined.

**Problem #4:** A methodology does not exist to objectively measure the properties of chronic wounds.

Medical professionals do not currently have a methodology for objectively and quickly assessing wound contamination. First, the level and type of correlation between tissue pH and bacteria levels is unknown. Second, techniques to utilize such a relationship in the clinical environment have not been established. Clinicians do not have a method by which they can effectively use a relationship between tissue pH and wound bacterial levels to diagnose a patient's condition.

Currently, clinicians do not have the capability to objectively measure the properties of chronic wounds. To determine a parameter that will accurately and efficiently estimate the properties of chronic wounds, several problems must be tackled. In this research, the parameter has been chosen to be tissue pH based on supporting evidence of its applicability to estimating tissue characteristics. Tissue pH has not been analyzed in the context of wound assessment and has not been compared to current techniques. Also, a simple methodology for measurement of tissue pH and the use of this measurement in clinical diagnostics has not been developed. A methodology for assessing chronic wounds using tissue pH would give plastic surgeons the ability to quickly determine the amount of bacteria present in the wound so that a decision concerning treatment would be based on an objective measure of the wound's condition. The development of such methods would greatly enhance the ability of plastic/reconstructive surgeons to confidently assess the cause of and proper treatment for chronic wounds.

The knowledge gained from the resolution of each of the four identified problems would aid surgeons in their quest for proper and efficient treatment of patients with chronic wounds. In addition, the determination of a correlation between tissue pH and bacterial levels in tissue would be a significant scientific contribution. It is very likely

that the characterization of such a relationship could be applicable to other area in addition to the prognosis of chronic wound properties. Therefore, this research has the potential to contribute to improvements in medical procedures in the clinical environment as well as to general scientific knowledge in the biomedical and related fields.

## 2. AIMS

The long-term goal of this research is to develop a methodology for achieving instantaneous and objective estimations of wound properties. The level of bacterial contamination in wounds is a well known indication of the condition of a wound; however, clinicians do not currently have a methodology or instrumentation to quantitatively measure the amount of bacteria in the wound without ordering lab tests that take several days. The determination of the level of bacteria in a wound is an important factor in understanding the cause of a wound's chronic behavior and the most applicable form of treatment. Previous studies have uncovered a correlation between a tissue's condition, including tissue perfusion and bacterial contamination, and its pH [1,3,4]. Taking this knowledge into consideration, the current research will focus on determining the applicability of tissue pH as a measurement tool for assessing wound properties, specifically related to wound bacteria levels.

To determine if tissue pH is an appropriate tool for estimating wound properties, a relatively strong correlation between pH and the bacterial count of the corresponding tissue under examination must be established. To determine if such a relationship exists, the first aim of the research is to develop a protocol to accurately and efficiently measure tissue pH and bacterial contamination. Although tissue pH is a familiar parameter to medical personnel, accepted procedures and equipment have not been developed for performing real-time tissue pH measurements using combination microelectrodes in the clinical environment. Thus, new methods must be developed to take isolated measurements of surface tissue pH. The next aim is to develop software algorithms to interpolate values from a limited number of pH measurements and form images of the entire wound area. These "pH images" will aid in characterizing the variation in tissue pH between different locations in the wound. The final goal will be to characterize the relationship between tissue pH and bacterial contamination.

Thus, the long-term goal is to provide plastic surgeons with techniques that can replace the current measures of bacterial contamination in the wounds of their patients. The new methodology will allow for real-time assessment of bacterial levels by measuring tissue pH. This will enable doctors to make judgments on the cause of a wound's inability to heal during or soon after a patient's visit. The appropriate treatment can then be determined based on this objective, quantitative measure, namely tissue pH.

This study is applicable to both chronic wounds and acute wound. Acute wounds are usually found in the emergency room; as a result, there exists a need to determine the level of contamination in the wound quickly and accurately to make timely decisions about wound closure and treatment. Chronic wounds persist over extended lengths of time due to several factors, one being the interference of bacteria in the healing process. The current research will focus on chronic wounds because of the availability of patients and relative ease in testing as compared to examining patients with acute wounds who are in critical condition.

In more detail, the specific aims required for the achievement of the goals of this research are as follows:

- Analyze current problems and define research specifications:
  - Investigate past achievements of researchers who have worked in the area of assessing wound properties.
  - Assess the current problems and gain background knowledge in the appropriate areas.
- Test the MI-414 electrodes, which will be used for measuring tissue pH, in the following areas:
  - Long term stability
  - Reaction time
  - Calibration time
  - Holding stability
  - Effects of Sterilization
  - Effects of Temperature
- Design a software program to acquire and process tissue pH data:
  - Develop an interface that accurately calibrates the MI-414 electrodes and measures the tissue pH using the pH meter developed by Gumbrell [4].
  - Develop a simple, easy-to-follow user interface.
  - Develop and implement algorithms for calculating point tissue pH measurements.
  - Incorporate typical Windows capabilities into the program.
- Perform bench tests on the tools and methods that will be used for animal and clinical testing:
  - Develop a quick and efficient technique for calibration.
  - Test the accuracy of the electrodes and pH meter.
  - Test the developed software program.
- Develop an animal protocol:
  - Determine specifications of bacteria that will be used for inoculation.
  - Determine most appropriate methods for achievement of the goals of the animal study.
- Perform animal studies:
  - Attain preliminary results on the correlation between pH levels and bacterial contamination.
  - Refine the calibration, measurement, and analysis steps in preparation for clinical testing.
- Perform clinical testing:
  - Develop a protocol for sterilization of MI-414 electrodes.
  - Record and analyze tissue pH in chronic wounds of a limited number of patients.
  - Obtain data on the bacterial levels of the chronic wounds.
  - Document the wounds with digital photographs.
- Develop a methodology for estimating a chronic wound's properties:

- Correlate the pH measurements to three different parameters: location in the wound, level of bacteria, and appearance of the wound.
- Determine a quantitative relationship between tissue pH and bacteria levels.
- Identify locations in the wound at which the pH is most highly correlated to the wound's properties, i.e. bacterial contamination.
- Minimize the number of measurements necessary to assess the wound's characteristics.

Thus, achievement of the outlined aims will result in the determination of a correlation between tissue pH and bacteria levels in chronic wounds. During the research process, a software program and testing protocol will be developed and used to perform animal and clinical studies. Although the clinical study will focus on the exploration of chronic wounds, determination of bacterial contamination is equally important in characterizing acute wound properties. The results achieved in this study will also have applicability in estimating properties of acute wounds because the research aims at determining an absolute relationship between tissue pH and its bacterial content. Ultimately, the goal is to develop a methodology for estimating wound properties that clinicians can use to measure the level of contamination in chronic wounds quickly, objectively, and with minimal invasiveness.



### 3. MAIN HYPOTHESES AND RESEARCH APPROACH

Several investigators have attempted to define a correlation between tissue viability and the level of tissue pH [2-7]. Many have concluded that the presence of ischemia causes a decrease in the measured tissue pH [3,4,6,7], yet none have quantitatively defined the relationship between tissue pH and bacterial levels. Thus, the present research will aim to quantitatively assess the correlation between these two parameters, specifically as it relates to the characterization of tissue in chronic wounds. The main goal of the research, as explained in the previous chapter, is to determine if and how the measured tissue pH levels can give clinicians accurate and helpful information in assessing the properties of chronic wounds. To pursue this goal, we must first establish several hypotheses and then develop an appropriate research approach.

#### 3.1 Hypotheses

*The first main hypothesis* is that tissue pH can be accurately measured in chronic wounds.

Few research efforts have involved surface tissue pH measurements. Several studies have been conducted during which tissue pH has been measured invasively. In the current research, we aim at taking point measurements on the surface of the exposed tissue in chronic wounds. This technique for testing have been chosen for the following reasons:

- It is a noninvasive method that causes minimal discomfort to the test subjects.
- Clinicians will be able to perform the method with minor preparation or knowledge of the technology; therefore, the research will have applicability in the medical field.
- It allows for the performing of tests in a short period of time because the electrode is simply held to the tissue surface and removed when a valid pH is obtained.

The instrument that was developed by Gumbrell [4] and the electrodes that have been chosen, which are manufactured by Microelectrodes, Inc., will be used to perform the point surface measurements. Results of taking measurements in this manner have not been previously reported, yet we are confident that this method will be accurate and efficient.

*The second main hypothesis* is that a relationship between tissue pH and the level of bacteria in wounds exists.

The level of tissue pH has been shown to be an indication of tissue perfusion. Our hope is to extend the applicability of this parameter and use it as an indication of the bacterial content of the wound. In order to establish the theory that tissue pH measurements are related to wound bacterial levels, a strong correlation between these two parameters must be established. Limited studies have been conducted in this area, but it has been noted that infected tissue exhibits relatively lower levels of pH. A quantitative relationship between pH and bacteria levels in tissue has not been established. The existence of this relationship is the main hypothesis of the research. It will be tested throughout the animal and clinical trials.

*The third main hypothesis* is that wound bacteria levels vary at different points in the tissue.

The level of bacteria in a wound affects the healing prognosis of that wound. It has been correlated to the success rate of a take of a graft after a tissue transplantation is performed. We aim at measuring tissue pH levels in chronic wounds and correlating them to varying levels of bacteria. The presence of varying levels of bacteria, although not beneficial to the patient, would aid in quantifying the correlation between tissue pH and bacterial content. Although tissue pH can be estimated at around 7.4 pH units, individuals have varying pH levels that result naturally from their chemical makeup. Correlating tissue pH and bacterial levels in one subject will represent a truer relationship, although we hope to conclude with generalizations that apply to all subjects. This will necessitate that varying levels of bacteria are present. Statistical techniques will be implemented to determine correlation within and among subjects' wounds.

*The fourth main hypothesis* is that it is possible to estimate tissue pH levels by interpolation from experimental data points.

During testing, a limited number of measurements will be taken from each subject. This will occur for several reasons: 1) the time spent with the subject must be kept to a minimum and 2) the number of biopsies taken from a subject must be limited. These requirements arise from the desire to facilitate the patient's needs. In the case of animal testing, the maximum number of biopsies that the lab can process at one time is fixed, limiting the sites that can be measured.

From this limited number of sites, we would like to get a picture of the pH information in the entire wound. This will help to get an understanding of pH levels across the entire wound without taking point measurements at numerous sites in the wound. Interpolation can be performed with a limited number of points, but the accuracy and usefulness of the interpolated pH values are questionable. Once the number of sites that can be tested is established, the use of applicable interpolation techniques will be researched and the appropriateness of these methods will be assessed.

*The fifth main hypothesis* is that given a correlation between tissue pH and bacterial contamination of a chronic wound, it is possible to develop an efficient methodology to help clinicians use this scientific information.

No definitive procedure for assessing wound bacteria levels exists today. Clinicians rely heavily on their experience to determine whether a wound is infected and to what extent. They base their decisions about methods of treatment and referral to surgery on their knowledge of indications that are encountered in each case. To ensure that the observations and decisions that the clinicians are making are accurate, an objective measure of wound infection is needed. Once a relationship between bacteria levels and tissue pH is realized, we aim to develop techniques to utilize this information in the hospital setting.

An important aspect of the research is to make a significant contribution to the medical field. The application of the scientific knowledge that has been gained throughout the research will constitute this contribution. Many researchers explore areas related to medical care and uncover new information, yet they do not explain how to efficiently use this information to aid patients. We believe that the information uncovered by this research can be used to form a methodology that clinicians can follow and gain valuable information about chronic wounds, which will benefit their patients.

### 3.2 Research Approach

Figure 3.1 shows the flowchart of the approach that will be taken for this research. Four main components can be identified: 1) software and algorithm development, 2) animal testing, 3) clinical studies, and 4) development of a methodology for clinical use. Software development will be ongoing throughout the research.

The first step in this research, indicated by the first aim, is to analyze and define the research specifications. Full understanding of the existing problems is an essential prerequisite to any research plan. In addition, the study should not repeat experiments that have appeared in past research. Therefore, a thorough investigation of the achievements and failures of past research efforts will be performed. By understanding the successes and shortcomings of researchers who have worked in areas related to this research, the research plan can be efficiently designed to minimize obstacles and maximize original results. Once the current problems are analyzed, an outline of the research approach can be formed.

The next specific aim is to achieve an understanding of the operation of the equipment that will be utilized in animal and clinical testing. The electrodes used to measure the tissue pH are the most critical pieces of equipment in this research. They will be in contact with the research subjects and are a main factor in the accuracy of the measurements. The electrodes must be carefully tested in all aspects of the research because faulty measurements will greatly affect the results. The pH meter, which was developed by Gumbrell [4], is the other essential component of the measurement system. The software controls the hardware operation. A software program will be developed to accurately read and display signals from the hardware and electrode combination.

Together, the pH electrode and pH meter, which is used to digitize and display the pH readings, will be tested to achieve full understanding of their operation. Several tests will be performed on the pH electrodes and pH meter to ensure accuracy in the testing and to allow practice of the procedures involved in this research. The results from each of the tests will contribute to the overall understanding of how to obtain accurate electrode calibration characteristics, to operate the combination of the developed pH meter and electrodes, and to identify environmental and testing factors that may affect the electrodes' accuracy.

Simultaneously, a software program will be designed to record the pH values and form a "pH image" of the wound that represents the variation in the tissue pH values over the entire wound area. Lab Windows will be used to develop a program with a simple and instructional user interface that can be operated by clinicians, nurses, and scientists. Several features will be incorporated into the software program, including typical Windows capabilities for data collection and storage. Also, algorithms to perform

interpolation and statistical analysis will be developed. Because of time constraints, a limited number of locations in the wound will be measured. The use of an interpolation algorithm will allow for the creation of an image of the pH levels of a chosen area of the wound, so that trends within one wound and between wounds of different patients can be analyzed. By developing a software program that will automate several of the research steps with an instructional user interface, the recorded pH values will be analyzed in an efficient and visually understandable manner.

The next three specific aims involve the testing of the chosen tools and parameters needed to perform this research. To properly determine the level of correlation that exists between tissue pH and bacterial levels in chronic wounds, the developed equipment and procedures must first be tested. Bench tests will first be performed on the developed methods and tools. The accuracy of the electrodes and developed pH meter will be validated. The calibration protocol will be tested for efficiency and correctness, and all aspects of the developed software program will be reviewed. Once the experimental apparatus is working as expected, animal and clinical studies can be performed.

Animal studies will be performed first to analyze the developed testing protocol and attain preliminary results. Tissue pH and the corresponding levels of bacteria in the artificially formed wounds in the animals will both be measured. The developed algorithms will be used to analyze the results and form pH images of the animal wounds. The animal studies will be used as a testing ground for future clinical trials.

Following animal studies, clinical trials will be performed. Again, the pH and bacterial levels in several areas of the patients' wounds will be obtained. A digital photograph of the wound area will be taken so that the appearance of the wound can be observed in relation to the pH and bacteria levels. The pH measurements obtained during clinical testing will be used to form pH images of the wounds. These images, along with the information about the amount of bacteria present in the wound, will aid in achieving the next specific aim which is to develop a methodology based on the correlation of the pH measurements to several parameters that describe a wound's properties.

Three parameters to which the correlation of tissue pH in the wound will be examined have been identified. The first is the location in the wound at which the measurement is taken. The location for each pH measurement will be recorded and considered in all the wounds tested to understand the variation in pH as it relates to relative distances within the wound. The second parameter is the bacterial levels in the tissue. Conventional methods for measuring bacterial levels will be performed in the animal and clinical testing to quantify the number of bacteria at chosen sites in the wounds. Finally, the appearance of the wound as it is shown in the obtained digital photograph will be considered. The color and texture of the tissue in the wound will be qualitatively compared to the pH and bacterial levels. Analysis of each of these parameters; location, bacterial levels, and appearance; and the knowledge of the wound's pH will allow for a complete understanding of the wound's properties.

Once results from animal and clinical studies are attained and the relationships between the discussed parameters are defined, a methodology for estimating bacteria levels found in chronic wounds will be developed. The methodology will include 1) measuring tissue pH in wounds and 2) using this information to estimate the level of

bacterial contamination in the wound. Bacteria levels are known to indicate the prospect of successful wound healing or graft survival. The developed techniques will be adapted to fit procedures that are ideal in the hospital environment. The relationship between tissue pH and bacteria levels in the wound will be defined quantitatively. Also, the general areas in a wound at which the tissue pH and bacteria levels are highly correlated will be determined in order to minimize the number of measurements needed to attain an understanding of a wound's pH and, as a result, the level of bacterial contamination.

The achievement of this final step will result in the accomplishment of the main research goal which is to apply the information that is discovered about tissue pH in wounds to actual clinical diagnosis and treatment. Although the determination of a strong correlation between pH and bacterial contamination would be an excellent scientific contribution, the development of procedures that will provide clinicians with the knowledge of how to use this scientific information is the most important contribution that can be made to the medical field.

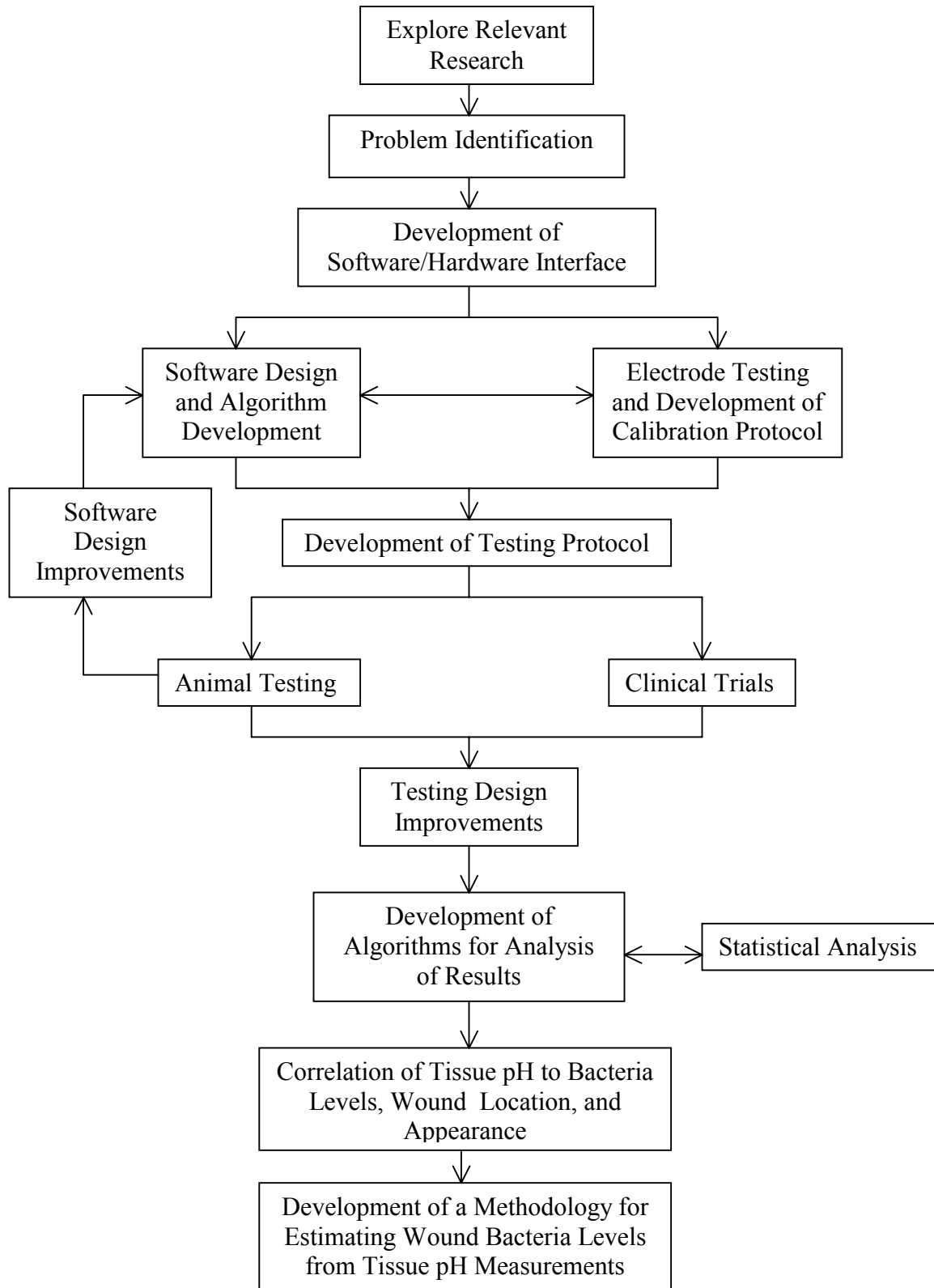
For clarification of this discussion, the research approach of this master's thesis has been broken down into the following steps:

1. *Research and organize the knowledge obtained in past research to define the current problems involved in assessing properties of chronic wound* – Achievements of researchers in the areas of chronic wound characterization, infection, and treatment will be researched to determine the existing problems in this area.
2. *Develop software/hardware interface and design software program* – The software drivers must be developed to allow for accurate reading of the pH measurements from the electrodes and hardware. Once this is accomplished, a software program that will read and display pH measurements as well as perform calibration will be designed and implemented.
3. *Test the pH electrodes that will be used in animal and clinical studies to measure pH* – The electrodes will be tested to fully understand their operation and to discover any limitations they may have in measuring pH under the conditions outlined by this research. These tests will aid in the development of a protocol for calibration, sterilization, and operation of the electrodes.
4. *Test the methods and tools developed for the research* – The tools that have been chosen for achievement of the research goals are glass pH microelectrodes, the developed pH meter, and a custom software program. The effectiveness and accuracy of these tools together will be analyzed before actual results are obtained. This will limit the possibility of complications during testing.
5. *Improve design of equipment and develop a final testing protocol* – Appropriate changes to the apparatus will be made and a testing protocol that includes procedures on sterilization, calibration, measurement, and analysis will be developed.
6. *Perform animal studies* – The developed tools and methods will be used to perform animal studies, obtain preliminary results, analyze the testing protocol, and make necessary changes.

7. *Perform clinical trials* – Outpatients with chronic wounds will be included in the clinical trials for this research. The tissue pH and bacterial levels of specified areas of their wounds will be measured and digital photographs of the wound will be taken.
8. *Develop algorithms to interpolate pH information* – Algorithms will be developed and implemented to create images of the tissue pH measurements from the limited number of measured data points. This tool will be used to allow for ease in interpolation and statistical analysis of pH values, organization of results, and management of data.
9. *Analyze the obtained data* – The data that is obtained from the animal and clinical trials will be analyzed using the developed software program. Relationships between tissue pH, the appearance of the wound, the bacterial contamination present in the wound, and the location of the measurement will be explored.
10. *Develop a methodology that clinicians can use to assess chronic wounds based on tissue pH levels* – The results from analysis of the clinical tests will be used to design procedures for using tissue pH as an indicator of the level of bacterial contamination in chronic wounds. The methodology will attempt to define a limited number of locations in the wound at which pH measurements can be taken to estimate wound bacteria levels.

These ten steps form a well-planned research approach. Each step attacks a different specific aim of the research. The improvement of the software program and testing protocol will be ongoing as new information is gained during the progression of the research. The final result will be the achievement of the research's main objective.

Thus, the aims of this research will be accomplished by following the described research approach. The outline of the approach provides the guidelines for the achievement of the overall research goal, which is to develop a methodology that will describe how to assess chronic wound properties by measuring tissue pH levels. The hypotheses will be used as a basis for many aspects of this research. The results of the research will determine whether each of the hypotheses can be claimed as a fact or a theory. This research is one of the many efforts in the exploration of wound assessment techniques and will contribute to the ongoing development of knowledge in this area.



**Figure 3.1: Flowchart of Research Approach**

## 4. BACKGROUND

This section of the text will give the background information on the topics that are fundamental to the understanding and undertaking of this research. The literature review strategy explains how the material used in the preparation of this chapter was obtained. The subsequent sections give insight into the history and development of wound care. Several words in the text are bold; these are medical terms that may be unfamiliar to the reader and are defined in section 4.8 of this chapter.

### 4.1 Literature Review Strategy

The collection of literature from areas related to this research was ongoing to ensure that all of the most recent material was reviewed. A majority of the literature was found at the University of Massachusetts Medical Library, which is an excellent source of periodicals in the medical and scientific fields. Several preliminary searches were performed using Medline, a search engine for medical journals. Review of the articles that were obtained initially allowed for other significant keywords to be identified and used to expand the literature search. In addition, the references at the end of the articles that were appropriate to this study were obtained. These techniques allowed for the attainment of a wide variety of references, including all the most recent studies pertaining to this research.

The majority of literature was found in periodicals because past research in the area of wound care has occurred in many isolated studies rather than a comprehensive text on the subject; this is typical of scientific research in areas that have not been fully established. Books were reviewed for basic background information on the following topics: principles of wound healing, the management of chronic wounds, reconstructive surgery, and the nature of chronic wounds. Searches for articles were performed in Medline and in the UMASS Medical Library in several major areas. The categories and keywords that were searched on are contained in Table 4.1.

Several of these searches resulted in the attainment of pertinent articles while other searches were too broad or did not result in any search findings. Many of the articles that were found in these searches were written in the mid-1950s to the early 1970s. This is not surprising because during that time, many professionals in the scientific and medical fields were interested in the management and assessment of wounds. This was a result of the war time troubles with wounds and the high percentage of amputations during that time. Since that period, isolated studies have been performed, but no widespread trends in researching new techniques for assessment of chronic wounds have arisen until recently.

The goal of the literature review was to attain an overall knowledge of wound management from the time of trauma or disease to the occurrence of surgery or sustained treatment. The research directly involves tissue pH measurements, yet to understand the context of the study and produce more meaningful results, the medical and scientific background of wound care should be understood. Obtaining information about the presence of bacteria in wounds and current methods for quantifying bacterial levels is also crucial to this study. A good understanding of the past and current literature will help to make the research more successful in presenting original results and applying



these results to the medical field. A complete list of the reviewed resources is contained in the bibliography.

*Table 4.1: Literature review categories and keyword searches*

<i>pH Measurements</i>	<i>Wound Contamination</i>	<i>Wound Treatment</i>
tissue pH	bacteria in tissue	bacterial levels and closure of wounds
pH and bacteria	bacterial counts in wounds	chronic wound treatment
pH of wounds	effects of bacteria on wound healing	reconstructive surgery
effect of temperature on pH	assessment of bacteria in wounds	antibiotic treatment of chronic wounds
pH measurements	assessment of wound contamination	wound healing
bacteria and pH	wound infection	
wound pH		
correlation between bacteria and tissue pH		

## 4.2 History of Wound Management

Interest in wound management originated in the mid-1800s when antiseptic measures, which were created to minimize infection and the involvement of bacteria in infections, were discovered. In 1878, Koch established the bacterial origin of wound infection [8]. The late 1880's saw the introduction of aseptic principles into surgery which aided in the reduction of the occurrence of surgical infection [8]. The war time era brought about many advances in wound care. The techniques of wound **debridement** (see Section 4.8 for a definition of this bolded term) were introduced during World War I, and the administration of antibiotics to infected wounds was improved during the Vietnam conflict. The preference of delayed over primary closure in the avoidance of infection was successfully established in World War I and reconfirmed in the subsequent war conflicts [9]. The frequent occurrence of wounds during war necessitated an increase in research in wound care.

Complications of war wounds also initiated studies on the quantification of bacteria in wounds. In 1917, French surgeons began to study quantitative bacteriology, and then in 1942, Altmeier found that bacterial cultures were necessary for intelligent management of wounds [10]. The gap between these two studies is due to the fact that, during that time interval, doctors and researchers turned to the approach of a more qualitative analysis of wounds. Then, in the late 1950's, studies were performed on the number of bacteria present per gram of tissue in the wound. It was discovered that greater than  $10^5$  bacteria per gram tissue caused failure of a tissue [10]. Surprisingly, this threshold is still held as a standard today.

Many reviews and supporting research of the discoveries made during the wartime were conducted during the 1960's and 1970's. As can be expected, several conflicting reports arose as more extensive research was performed on wound management and treatment. In the 1970's, the effects of the placement of wounds in a sterilized environment on infection rate was considered [11]. In addition, several methods for assessing wound contamination were developed including wound irrigation and swabbing of the wound. As time passed, more specific studies were conducted on bacterial quantification, and numerous researchers confirmed the level of crucial bacteria in a wound to be less than  $10^5$  bacteria per gram tissue [12,13,14]. New forms of

antibiotics and their affect on wound healing were focused on, and the prediction of wound graft survival by consideration of preoperative indications was a leading topic of study.

Although an abundance of research has been performed in the area of wound assessment and contamination, “assessment of healing in a clinical setting is typically done using a series of visual and physical observations” [15]. Even today, with advances in technology, definitive measures for analyzing a wound have not been fully developed. Several researchers have worked on methods for quantitative analysis of wounds, yet it has not resulted in techniques that are used in practice in hospitals today [15,16,17]. Thus, this field is still underdeveloped, and the addition of new knowledge will be seen in the years to come.

### 4.3 Economics of Chronic Wound Care

One of the major driving forces of researching new techniques for wound healing is the high cost of wound care to the patient, hospital, and community. Any condition that causes a patient to stay in the hospital uses up valuable resources. Minimizing the number of patients with wounds who reach the point of hospitalization would be greatly beneficial. It has been estimated that each year approximately 8 million people in the United States suffer from chronic skin loss or ulceration [15]. Although the cause of these medical problems varies widely, many of these cases are persistent and necessitate long term medical care.

The greater the length of medical intervention, the higher the cost. Cost takes into account much more than simply the monetary value needed to treat the wound. If the patient needs to take time off from work due to his/her wound, financial loss, and psychological effects will increase. This may have implications for the patient’s family as well. Any medical regiment that requires a person to alter his/her way of living will cause complications and increases the overall “cost” of the injury. The psychological effects of a chronic wound are difficult to measure but are definitely present and are most likely underestimated.

It has been estimated that the cost of treating one ulcer ranges from \$1,000 per inch diameter of the wound to as high as \$10,000 [18]. These costs have surely risen since this study was done over a decade ago. Wound care, dressing, medications, supplies, hospital stay and surgery are accounted for in these estimates. Outpatient costs are also extremely high. For supplies, physician visits, and clinic costs, Rudolph estimated that a patient with a **venous stasis** (see Section 4.8 for a definition of this bolded term) ulcer could incur costs of \$3,000 per year on average [18]. The cost to the general public, the majority of whom do not suffer from chronic wounds, is even more astounding. It was estimated that in the 1980’s, American society paid as much as \$655,000,000 for the treatment of venous stasis ulcers. A report in 1998 estimated the cost of chronic wounds to exceed \$3 billion a year [19].

Obviously, the longer it takes for a wound to heal, the more the cost will increase. Thus, it is important to attain a better understanding of the process of wound healing and treatment in order to decrease patient suffering and the financial cost to all parties involved. The discovery of cost-effective measures to understand a wound’s properties and appropriate treatment will benefit patients, hospitals, and society.

#### 4.4 pH Theory and Measurement

pH is a measure of the concentration of hydrogen ions in a medium. “pH” stands for pondus hydrogeni and was defined by Sorenson in 1909 as the negative logarithm of the concentration of hydrogen ions in an aqueous solution [20]. This definition conditioned on the assumption that hydrogen ions were the only ions present in the solution, yet this is never true in aqueous solutions. Therefore, in 1924 the definition was redefined in terms of the activity of hydrogen ions. Because of the influence of other ions in a medium, pH is only an approximate value of the hydrogen ion concentration.

pH is a measurable parameter that is familiar to all professionals in the scientific and medical fields. This is one of the major advantages of using it in clinical practice. pH can be measured by several mechanisms, from litmus paper to high tech pH meters. For clinical pH measurements, a glass electrode is used. It consists of a thin glass bulb, inside which is mounted a silver electrode. The silver electrode is immersed in a solution of constant pH that contains ions to which the electrode is reversible [21].

Figure 4.1 is a graphic of the specific glass electrode that will be used in this research. It is a micro-combination electrode in which the reference electrode, composed of Ag-AgCl, is included. Microelectrodes, Inc. donated several of these electrodes for this research. Figure 4.2 shows a typical glass electrode. These electrodes are extremely fragile, and great care must be taken in handling, cleaning, and storing them.



Figure 4.1: The MI-414-2cm electrode manufactured by Microelectrodes, Inc.

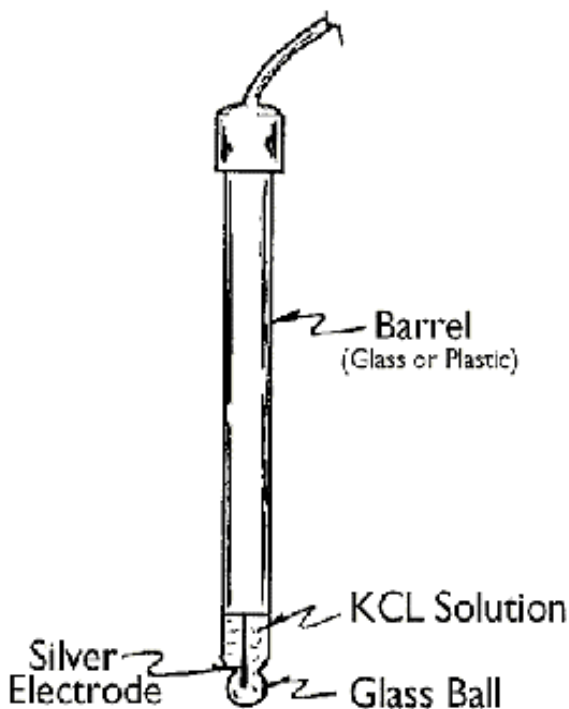


Figure 4.2: An example of a glass electrode. The ball at the end of the pH electrode is composed of a special glass which has specific surface properties. The glass ball should not be allowed to dry out because it is sensitive to cracking.

Glass electrodes produce a linear output voltage which corresponds to a pH between 0 and 12 units, and the time to obtain 90% of their final value is theoretically within two seconds [20]. The drawbacks of glass electrodes are the high cost and the problems with their sterilization.

The pH of a solution is a quantity defined by the following relationship:

$$\text{pH} = -\log [\text{H}^+] \quad (4.1)$$

where  $[\text{H}^+]$  signifies the activity of  $\text{H}^+$  ions. Because single ion activities cannot be directly measured, pH must be measured in relation to other solutions with known values of pH.

The basis of pH electrode measurement is the following: when the electrode comes into contact with a sample, a potential develops across the electrode's membrane surface. This potential varies with the concentration of ions in the solution. A second unvarying potential to compare this membrane potential to is required and is provided by the reference electrode which must be in electrical connection with the same sample to close the electrical circuit. The reference electrode may be a separate unit or contained within the same assembly as a combination electrode. The filling solution, 3M KCl in this research, completes the electrical circuit between the sample and the internal cell of the silver electrode. The potential difference between the silver and the reference electrode is read and converted to a pH value by using the electrode's specific calibration constants. Thus, electrodes must be calibrated in two or more buffers in order to calculate their characteristics and convert the voltage reading into a pH value. The calibration characteristics are found by the following equations:

$$s = -(E_1 - E_2) / (\text{pH}_1 - \text{pH}_2) \quad (4.2)$$

$$E' = (E_1 - s \text{pH}_1) / T \quad (4.3)$$

where  $s$  is the slope and  $E'$  is the intercept of the characteristics. The theoretical slope for a pH electrode is  $-59.16 \text{ mV/pH}$  units.  $E_1$  and  $E_2$  are the voltages measured when the electrode is immersed in the selected buffers with known pH values,  $\text{pH}_1$  and  $\text{pH}_2$ .  $T$  is the temperature of the solution in Kelvin. Once these variables have been calculated, the pH of the solution in question can be determined by the following equation:

$$\text{pH} = (E - \Delta E_{lj} - E' T) / -s \quad (4.4)$$

where  $E$  is the measured voltage of the solution in question and  $\Delta E_{lj}$  is the difference in liquid junction potential between the buffers and the actual solution being measured (discussed below).

Three major factors that affect the accuracy of pH measurements are ionic strength, temperature, and pressure. The buffers that are available on the market have low ionic strength. If the medium that one is measuring has a higher ionic strength, changes in the liquid junction potential of the reference electrode will most likely occur. This will cause a variation in the measured pH from the actual value. The difference in

liquid junction potential can be determined by measuring the change in potential in a solution containing a given amount of HCl when a salt is added.

pH also varies with the temperature of the medium that is being measured. Thus, the temperature should be taken into consideration when determining the true pH of the medium because the calibration characteristics will change for different temperatures. The third factor affecting pH, which is pressure, is not as straight forward. It has varying effects, but pressure effects can be determined by measuring the pH of a buffer at high pressure and then comparing the result to the theoretical value. This factor is not significant when using glass electrodes because they contain pressure equilibration between the inner and outer part of the electrode. Thus, many parameters influence pH measurement, making them unstable. Therefore, calibration must be performed meticulously and the pH electrodes should be examined for all of the issues that may affect their performance.

pH measurements will be taken of tissue in this study. Thus, the following questions must be addressed: what complications occur in measuring tissue pH? and what knowledge is available in this area? Harrison and Walker studied the pH of the dermis of the human skin under different conditions [6]. They found that the mean value of skin pH was  $7.54 \pm 0.09$  by using a glass microelectrode inserted into the dermis. Their experiments included correction for temperature effects as well as the depth of insertion of the electrode into the skin. Another study analyzed the effects that various factors had on pH electrode performance in biological experiments. It was recommended that “calibration should be done with standard solutions which have almost the same components as the test samples at the same temperature at which the biological measurements are made [22].”

Due to the difficulties that are encountered with pH measurements, a limited number of studies have been performed on the effectiveness of this parameter in the clinical environment. It cannot be ignored that pH is a widely accepted parameter and can put the evaluation of a given medium into context. The complications of pH measurement must be carefully dealt with so that electrodes can be used accurately and without difficulty.

#### **4.4.1 Trends in Tissue pH Levels**

One area in assessment of wounds that has been widely researched in the last few decades is the relationship between tissue **ischemia** and tissue pH. In the 1970's, studies began to appear on the effect of the occurrence of ischemia on pH levels. Researchers were in agreement that tissue pH falls during ischemic events [6,7]. The premise is that a decrease in blood flow to a tissue is accompanied by anaerobic metabolism which produces lactate. The presence of lactate contributes to an increase in  $H^+$  ion activity, which is proportional to a decrease in pH. Thus, pH can be used as an indication of a reduction of tissue **perfusion**.

Wolpert et al. compared serum pH measurements to that of tissue pH [7]. They found that although serum pH is more stable than tissue pH, several advantages of tissue pH as the measurement parameter of choice were apparent. Tissue pH reacted earlier to changes in tissue perfusion and can be measured with minimal invasiveness. The

difficulties that were encountered, and are still seen today, concern the pH electrodes used for measurements.

Several researchers have studied the use of tissue pH as an indication of the metabolic state of a tissue [3, 23]. Dickson and Sharpe compared tissue pH monitoring with other more traditional techniques and found that pH predicted the onset of flap **necrosis** sooner and better than other methods [3]. In another aspect of assessment of wound properties, Ye looked at the relationship between tissue pH levels and subsequent graft survival of surgical wounds [1]. This is an important study because an accurate indicator of whether surgery should be performed would be extremely beneficial. Although postoperative monitoring of tissue flaps is crucial, if it is known how successful the take of a graft will be before the surgery is performed, many complications can be avoided. Ye found that the optimal pH of tissue in a wound is about 7.4; any fall in the pH corresponded directly to a drop in the success rate of a tissue graft.

One question that arises from this study is what factors in the wound contribute to the drop in tissue pH that indicate skin graft survival rates. Ye hypothesized the decreased levels of tissue pH were due to bacterial infection, the presence of **exudate**, and decreased blood supply; but he did not isolate these factors. Ye's study lends itself directly into the current research.

#### 4.4.1.1 Physiological Basis of the Relationship between Bacteria and pH

The presence of bacteria in a wound may decrease the tissue pH level below its normal value (approximately 7.4). This will occur because the bacteria that is present will be in direct competition with the tissue cells for nutrients and oxygen. This leads to the development of ischemic conditions in the wound tissue. This will result in hypoxia and the tissue's metabolism becoming more anaerobic and therefore acidic. As the bacteria thrives, it will use more of the oxygen that is essential for the maintenance of healthy tissue. The production of lactate will follow which will further lower the tissue's pH to a more acidic level. These physiologic mechanisms indicate that increased levels of bacteria are accompanied by decreasing levels of tissue pH. This is the hypothesis that is being tested in this research.

It is difficult to separate the effects of bacteria and tissue vascularization on tissue pH levels as Ye commented on in his research [1]. The presence of bacteria may cause a decrease in tissue perfusion which will decrease tissue pH levels. Conversely, a lack of vascularization in a given area may create an environment that bacteria can thrive in; thus, the low blood perfusion is the initial cause of a decreased tissue pH and the presence of bacteria further compromises the tissue's health. The final result is that the tissue pH will be altered from its normal level of approximately 7.4 pH units. The mechanisms by which this occurs are not completely understood. Bacteria can survive at a range of pH levels, while keeping their internal pH fairly constant. Therefore, it is possible that several strains of bacteria grow best in an environment of higher (or more alkaline) pH levels. Thus, elevated levels of tissue pH may be a result of the presence of these types of bacteria.

#### 4.4.2 *Analysis of pH Values*

Once tissue pH began to be established as an indication of tissue properties, it was necessary to understand how to analyze the information that was attained during measurement. Long term studies of tissue pH have been performed to monitor the metabolic status of a tissue [4, 23]. The resulting information has been analyzed using several signal processing statistical analysis techniques [24-26]. The measurement of tissue pH in wounds at isolated locations necessitates alternate analytical techniques, taking into consideration variations in the pH due to the depth of the electrode and the amount of exudate present. No studies were found that analyzed point-by-point pH measurements, as will be conducted in the current research.

#### 4.5 *Causes and Types of Wounds*

Wounds are caused by various mechanisms and exist in many forms. Wounds result from trauma that may be involved in an isolated incidence or may develop over time. An example of an isolated incidence would be an accident during which an individual's skin and underlying tissue layers are severed. Long term development of wounds may occur in patients with diseases such as diabetes. Depending on their nature, wounds can be classified as acute or chronic.

##### 4.5.1 *Acute Wounds*

Wounds that result from a traumatic incidence are classified as acute wounds. Acute wounds result from mechanical or thermal stresses on the soft tissue of an individual [27]. Mechanical force to the skin may involve shearing, tension, and/or compression. Shearing is a result of friction of an object against the skin, causing tissue **devitalization** but minimal risk for long term injury and infection. Tension involves the stretching of tissue resulting in the tearing of the tissue. Compression occurs when tissue collides with an object with enough force to cause damage to the soft tissue. These types of traumatic wounds have a high risk of infection.

Traumatic wounds that result from thermal injury are caused by exposure to extreme temperatures, electrical or chemical factors, contact with a hot surface, or radiation [27]. Although burn injuries are more common, tissue damage due to exposure to extremely cold temperatures also classify as traumatic wounds. The length of time that the tissue is exposed to the extreme conditions is the number one factor in dictating the extent of the injury. Acute wounds are usually dealt with as emergencies. Once initial assessment is performed, closure by sutures or surgery may be employed.

##### 4.5.2 *Chronic Wounds*

If the wound does not heal in a given amount of time, its classification will be changed from acute to chronic. The period of time that a wound must persist before it is considered chronic is subjective and relies on the location of the wound and the age and condition of the patient [19]. The basic principle is that if the wound does not exhibit normal response to injury in a timely fashion, it is considered a chronic wound. The normal healing response of a wound is summarized as follows. Trauma that causes the extracellular area of tissue to be exposed will result in the collection of **platelets** to this area to stop bleeding. This leads to the inflammatory phase, in which **neutrophils** leave

the circulation allowing for debridement of devitalized tissue and **phagocytosis** of foreign bodies [19]. The next phase is the **proliferative** phase, or the phase of repair. During this phase, the matrix of the tissue begins to reconstruct. **Collagen** is the most crucial element in the remodeling of the wound tissue and the formation of a scar. Any extended disruption of this natural process will allow for the development of a chronic wound.

Several factors exist that may inhibit the healing of a wound and allow it towards progress to the “chronic” classification. These factors can be broken down into local or intrinsic factors (relating to the wound itself) and extrinsic factors (systemic influences). Table 4.2, taken from Ramasastry’s article on chronic problem wounds, displays common causes of a wound’s resistance to heal [28].

*Table 4.2: Factors that impair wound healing*

<b>Intrinsic Factors</b>	<b>Extrinsic Factors</b>
Ischemia	Nutritional deficiencies
Infection	<b>Diabetes mellitus</b>
Foreign Bodies	Chronic renal failure
Cigarette Smoking	Steroids
Venous insufficiency	Chemotherapeutic agents
Radiation <b>fibrosis</b>	Old age
Repeated trauma	Liver disease
Local toxins	Some drugs
Cancer	Hereditary

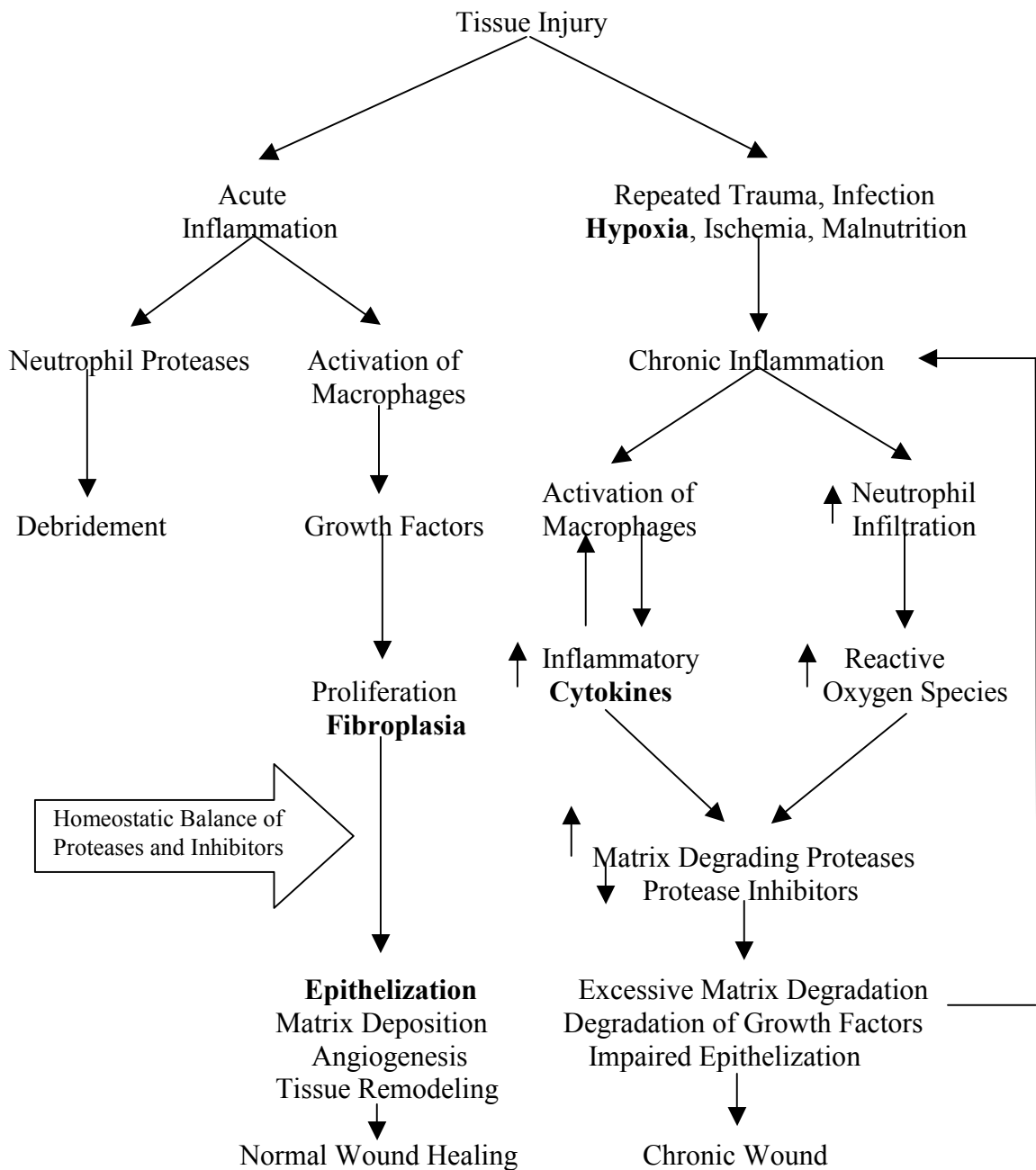
Each of these factors necessitates different wound care efforts. It is important to correctly assess the reason for the wound’s inability to heal. Misdiagnosis may lead to unnecessary treatment. Often, several of the above factors will together affect the healing of a wound, making a definitive diagnosis difficult. Technological advances in wound care have helped in these types of determinations, but further progress is needed.

Chronic wounds are most common in elderly patients. Seventy percent of the wounds found in these patients are due to the presence of chronic venous stasis, diabetes mellitus, and pressure necrosis [19]. Pressure ulcers are characterized by extensive tissue necrosis and often necessitate bed rest. Venous ulcers result from chronic venous insufficiency, commonly in the lower extremities. Diabetic ulcers are a result of ischemia, repetitive injury, and neuropathic problems [19]. They are susceptible to infection due to the insufficient resistance to **pathogens** that diabetic patients possess. The implications of these diseases are widespread. Patients are often bedridden, creating socioeconomic and financial effects.

Thus, chronic wounds are characterized by a prolonged inflammatory state and a resistance to heal. Figure 4.3 displays the progression of a normal healing wound opposed to one that becomes chronic. The cause of the wound’s chronic nature may be one or several of the above mentioned factors. The reason that a wound is not healing will be different from patient to patient. Currently, there is no universally accepted



criteria for the explanation of a wound's pathophysiology. "There is an urgent need to bridge the gap that often exists between laboratory research and clinical practice" [19]. The development of new methods and instrumentation will aid clinicians in their quest to efficiently heal chronic wounds.



**Figure 4.3: The physiology of normal wound healing and pathophysiology of chronic wounds.**

#### 4.6 Wound Infection

One of the most common reasons for the repetitiveness of wound inflammation and the inability for the wound to progress to the proliferative stage is wound infection. Because this is an area that will be focused on in the current research, the implications of wound infection will be discussed briefly here.

Infection in the clinical environment can be defined as “the product of the entrance, growth, metabolic activities, and resultant pathophysiologic effects of microorganisms in the tissues of the patient” [29]. This is to say that the invasion of pathogens in tissue and the disruption of the natural mechanisms of the tissue’s cells constitutes an infection. A wound is proclaimed infected when the bacterial count exceeds  $10^5$  per gram of tissue [28]. The presence of such a level is most likely the result of an insufficient immune response, which is often due to an underlying disease. If the equilibrium between bacterial activity and host resistance is disturbed, infection will begin to develop in the tissue area. Noticeable signs of wound infection include extreme discomfort, continuous wound drainage, redness beyond wound boundaries, swelling, and fever. Wound infection affects the natural healing of a wound by increasing the percentage of tissue destruction and changing the content of the wound’s tissue sufficiently so as to impair healing.

Several factors affect a wound’s resistance to infection. The four major ones are as follows:

- patient age – likelihood of wound infection increases after twenty-four years of age;
- nutritional status – obesity or malnutrition affects a patient’s immune response;
- **glucocorticoids** – presence is beneficial to inflammatory response; and,
- decreased perfusion – causes an increase in infection rate [18].

Another factor that allows for a higher rate of infection is the time that elapses between the trauma that causes the wound and the cleansing and/or repair of the wound. It is plausible for bacterial levels can increase  $10^3$  times within a five hour period of neglect. Normal skin may contain up to  $10^3$  bacteria per gram tissue while more than  $10^5$  bacteria per gram tissue will result in a high probability of infection [13].

Once the stage has been set for the invasion of bacteria, foreign bodies can be introduced from various sources. The two major categories of bacteria origin are exogenous (from the environment) and endogenous (from the host) organisms. Sources of exogenous contamination may be the instrument of injury, operating personnel, and/or the environment. Endogenous factors include foreign bodies, **hematoma**, dead space in the wound, necrotic tissue, and disease. It has been found that airborne bacteria do not significantly contribute to the wound’s bacteria level, and the host is the major source of contamination [18].

The occurrence of wound infection relies heavily on the mechanism of injury. If the trauma that caused the wound is highly contaminated in nature, the wound is more likely to become infected. Therefore, the following characteristics of a wound play a role in the subsequent level of infection: type of injury, area of injury, level and type of bacterial contamination associated with injury, amount of destruction of local tissue and

its defenses, degree of alteration in local physiology, and time elapsed since injury [13]. The following patient's characteristics also highly affect the probability of infection: age, diabetes, steroid use, obesity, malnutrition, and presence of other infections. The location of the area on the body at which the wound is present also affects the chance of infection. Locations that have greater blood supply will not become contaminated as badly because a better immune response can be employed.

Surgeons can further classify wound infections as pre-, peri-, or postoperative. Each type of infection is a result of the stage in which the wound exists. The source of the infection will also differ. Preoperative infections are a result of the endogenous and exogenous influences found at the time of injury up until the time of surgery, if it is necessary. Perioperative infections will result from factors present during operation. Whyte et al. studied the effects of airborne bacteria and surgical materials in the operating room [30]. They discovered that the patient's skin was a more significant contributor to wound infection than the surrounding environment. Davidson et al. attempted to pinpoint the most common sources of postoperative wound infections, using a large patient sample [31]. The researchers gained information about the patients, their wounds, and the characteristics of the surgery they underwent. The factors that were most influential in the occurrence of postoperative wound infection were the patient's age, the duration of surgery, the surgical environment, and the bacteria present in the wound at the end of surgery.

The amount of bacteria present in the wound is therefore an indication of the likelihood of the development of infections. Several methods have been used to measure the amount of bacteria present in a wound [32]. Bacteria can be quantified by taking tissue biopsies from the wound surface. These biopsies take approximately forty-eight hours to culture and obtain bacterial growths. A rapid-slide technique has been developed by which direct microscopic measurements of the total number of bacteria can be calculated within fifteen minutes, yet this technique is not entirely reliable and is used mostly to confirm results of more thorough tests. Older techniques include the use of an agar contact plate, contact sponges, and flamed wound biopsies, all of which take twenty-four to forty-eight hours to attain bacterial information about the wound.

The level of bacterial contamination in a wound has been found to be useful as a predictor of the success rate of a tissue transfer [1, 12, 14, 33, 34]. Schneider et al. explored the use of single point and multiple point tissue sampling in infected wounds to research the feasibility of bacteria levels as an indicator of graft survival [12]. They concluded that single point tissue sampling was not representative of the contamination level of the entire wound. The bacterial contamination varied throughout the wound, necessitating that several points be sampled if bacterial levels were to be used to predict the success rate of an operative closure. Robson et al. discovered a ninety-four percent graft survival rate if the wound bacteria level is less than  $10^5$  counts/gram tissue and a fourteen percent survival rate if the bacteria level was greater than this threshold [14].

Wound infection is a major cause of a wound's inability to heal. It causes much pain and suffering for the patient and necessitates a large financial obligation for proper treatment. Infections can result from various sources at several different points in a wound's progression. This makes it extremely difficult to develop universal characterizations of infection types. Bacterial quantification is a useful tool for attaining

an understanding of the contamination level of the wound. The development of more efficient and definitive tools for the assessment of wound infection is greatly needed.

#### 4.7 Wound Treatment and Healing

Initial inspection of a wound must be meticulous because several factors affect the type and extent of treatment that is needed to allow for proper healing of a wound. “Quantitative and definitive characterization of both the initial and evolving status of wounds is essential for the proper treatment” [15]. A thorough history should be taken, involving the request of the following information: mechanism of injury, age of wound, allergies, tetanus immunization status, and diseases. The wound should be inspected for the location of the wound, length, depth, and shape, nerve function, tendon function, evidence of contamination, and range of motion [35]. Natural wound healing will occur unless there are significant effect from infection, tissue devitalization, patient disease, and/or poor repair technique.

Wound tissue is made up of two major layers, the epidermis and the dermis. The epidermis is composed of the stratum germinativum, which provides the cells necessary for formation of epidermis during wound healing. The dermis contains connective tissue which provides stabilization of **percutaneous** and deep sutures needed for wound closure. The goal is to close the wound in a timely manner, taking into consideration the preservation of tissue and avoidance of infection and scar tissue formation.

Wound healing can be divided into three phases: the substrate phase, the proliferative phase, and the remodeling phase [36]. Once the tissue is injured, inflammation occurs immediately. Subsequently, a clot composed of surface **epithelium** and **fibrin** holds the wound edges together. After two to three days, the proliferative phase begins during which collagen synthesis is occurs. After six weeks of active collagen formation, the remodeling phase takes over. This phase can last up to several months and is characterized by the changing and strengthening of the collagen network. This describes the timeline for a “healthy” healing wound. The time intervals of each phase for an infected wound would be much greater.

Surgeons can aid in the process of wound healing in several ways, the most common being wound closure. The most crucial aspect of wound closure is the timing and choice of closure. Wound closure can be divided into three major categories: primary, secondary, and tertiary closures. Primary closure is performed on lacerations that are uncontaminated and involves closure by the application of sutures. Secondary closure involves the gradual closing of the wound by its natural mechanisms. Cleansing, irrigation, and debridement are necessary to prevent infection. Tertiary closure is invoked in older wounds that are badly contaminated. These wounds are observed for up to five days and treatment is continually being reassessed. Antibiotics are usually administered, and closure is not considered until bacteria levels drop.

Wounds that have significant tissue loss necessitate skin grafts or flaps. Skin grafts are portions of dermis that are completely detached from the body at the time of transfer. They are used for wounds that have an intact capillary circulation [36]. Flaps differ from skin grafts in that they provide circulation to the wound site and provide additional soft tissue to the deprived wound area.

Several conditions will slow down the healing process. Older patients, chronic alcoholics, and diabetics all experience slower healing. Uremia, which causes the inhibition of fibroblast growth, may develop and induce complications. Cancer, **hepatic** failure, cardiovascular disease, and trauma will cause the failure of oxygen and nutrients to reach the wound. Most drugs have an adverse effect on the progression of wound healing while supplements such as vitamin C, A, zinc sulfate, and anabolic steroids stimulate healing [35].

If a wound becomes infected, medical intervention is necessary. Without assistance, most infected wounds will remain chronic and may require limb amputation, in the extreme case. The goal is to reestablish the balance between the tissue and bacteria so that closure can be enacted. Therapies include drainage of an **abscess** and debridement of necrotic tissue, hematoma, and foreign bodies [29]. Antibacterial agents have been used increasingly in the past few years to prevent and treat wound infections. If purulent material is present in the wound, it should be irrigated. This is an indication of significant infection, and a tissue biopsy should be taken from the wall of the abscess for inspection of bacterial content [29]. If the wound is infected (meaning the bacterial count is greater than  $10^5$  bacteria/gram tissue), then medical therapy must continue. Once the wound tissue is not considered clinically infected, closure may be initiated, unless extreme amounts of tissue are missing, making grafting necessary.

It will often take several months for the entire process of wound healing to be completed. Several parameters can be measured to attain an understanding of whether a wound is progressing or has developed into the chronic category. "Healthy" wounds will consume amino acids, carbohydrates, lipids, oxygen, and produce carbon dioxide and hydrogen ions. Each of these factors can be measured throughout the healing process but not without difficulty. Several studies have attempted to correlate physiological parameters to the health and status of a wound [2, 37, 38, 39]. Lim et al. looked at the change in metabolic parameters as nutritional blood flow was restored to the wound over time [38]. Using an animal model, they measured pH, PO<sub>2</sub>, pCO<sub>2</sub>, and lactic acid and found that these parameters reflect the metabolic state of the wound at the edges of the granulation tissue. From their experiments, they concluded that blood flow increases to the wound during the first two weeks and remains constant for another two weeks as the wound becomes healthier. Lengheden et al. found that the optimal pH in humans for proper wound healing was around 7.5 [2].

If the healing of a chronic wound does take an extended period of time, the wound must be "managed," which is a term that is used after initial treatment of the wound does not entirely resolve the medical condition. Both extrinsic and intrinsic factors must be controlled. Extrinsic factors, which are more difficult to manage, include disease, nutrition, alcoholism, and diabetes. These factors/habits can be changed by employment of strict eating regimens, alteration of social habits, control of blood sugar, and use of pharmaceuticals. Thus, proper management of chronic wounds would involve the following actions: bed rest, reduction of edema, control of host medical problems, local wound care, control of infection, pharmacological therapy, **hyperbaric** oxygen, debridement of wound area, correction of arterial inflow, skin graft, and/or microvascular flap transfer [28].

Gerit D. Mulder wrote an excellent article, which summarizes the current knowledge in wound care and the problems surrounding it [39]. One major problem is that scientific advances do not usually reach the clinical setting where they could have major impact. Mulder explains that although an enormous amount of money has been spent on the development of technology for wound care, a very small percentage of these advancements have applicability in the hospital. He discusses the advantages and disadvantages of animal models and emphasizes that although animal studies are absolutely necessary, more emphasis should be put on clinical studies, when possible, to allow for a realistic setting for testing. Many products have been developed over the years to aid in the wound healing process: occlusive dressing that allow for facilitated cell migration, topical solutions that eliminate cytotoxicity, and products that claim to stimulate cellular activity [39]. Although these products may be beneficial, the clinicians make the final decision concerning treatment; therefore, clinical acceptance must precede successful introduction of new products. “Clinically supported scientific knowledge of function and effect of wound repair products will promote the acceptance of new technology, expedite wound closure, and improve patient care ... “ [39].

Several new developments are continually being introduced into the field of wound care. Many of these do not have significant impact, while others may come to be mainstays in the treatment of chronic wounds. Some of the recent trends are stimulating wound healing with genetically engineered agents, using synthetic skin substitutes, and using hyperbaric oxygen [27]. Research efforts are ongoing in the development of a realistic and reproducible epidermal growth factor. These growth factors occur naturally in the wound and aid in wound healing by promoting the migration of epidermal cells, angiogenesis, collagen deposition, and **chemotaxis** of inflammatory cells [27]. The application of such growth factors to a wound that is unable to heal on its own would be beneficial. Human growth hormones are also being explored as stimulants of protein synthesis and tissue growth.

A therapy that has proven useful is the application of hyperbaric oxygen. Wound tissue needs an abundance of oxygen for several of the key steps in healing (collagen synthesis, tissue growth, and angiogenesis). Thus, the introduction of hyperbaric oxygen helps the wound to proceed in the healing process. If the wound will not heal with the aid of topical agents and hyperbaric oxygen, a tissue transfer becomes necessary. Surgeons now have the option of using cultured epithelial **autografts** (CEA). Although there are still disadvantages of this graft choice over traditional split-thickness skin grafts, “the cultured epithelium produces a variety of growth factors that promote healing,” allowing for a decrease in the time needed for re-epithelialization [27].

Thus, several advancements in wound care have been made. A closer look still needs to be taken at the actual mechanisms of wound infection. This will enable better measurement tools and therapeutic products to be developed. Many possible areas for research in wound management and treatment are apparent. Combined efforts of scientists and clinicians will allow for the introduction of new technologies that have real applicability in the clinical environment.

#### 4.8 Glossary of Medical Terminology

**Abscess** – a circumscribed collection of pus appearing in an acute or chronic localized infection, and associated with tissue destruction, and frequently, swelling.

**Angiogenesis** - development of blood vessels.

**Autografts** – a tissue or an organ transferred by grafting into a new position in the body or the same individual.

**Chemotaxis** – movement of cells or organisms in response to chemicals, whereby the cells are attracted or repelled by substances exhibiting chemical properties.

**Collagen** – the major protein of the white fibers of connective tissue, cartilage, and bone.

**Cytokines** – generic term for nonantibody proteins, such as lymphokines, released by a certain cell population on contact with a specific antigen and which act as intercellular mediators, as in the generation of immune response.

**Debridement** – excision of devitalized tissue and foreign matter from the wound.

**Devitalization** – deprivation of vitality or of vital properties; dead.

**Diabetes mellitus** – a metabolic disease in which carbohydrates utilization is reduced and that of lipid and protein enhanced; it is caused by an absolute or relative deficiency of insulin.

**Epithelium** – the purely cellular avascular layer covering all the free surfaces, cutaneous, mucous, and serous, including the glands and other structures derived therefrom.

**Epithelization** – formation of epithelium over a denuded surface.

**Exudate** – any fluid that has exuded out of a tissue or its capillaries, more specifically because of injury or inflammation, in which case it is characteristically high in protein and white blood cells.

**Fibrin** – elastic filamentous protein derived from fibrinogen by the action of thrombin, which releases fibronopeptides A and B from fibrinogen in coagulation of the blood.

**Fibroplasia** – production of fibrous tissue, usually implying an abnormal increase of non-neoplastic fibrous tissue.

**Fibrosis** – formation of fibrous tissue as a reparative or reactive process, as opposed to formation of fibrous tissue as a normal constituent of an organ or tissue.

**Glucocorticoids** – any steroid-like compound capable of significantly influencing intermediary metabolism such as promotion of hepatic glycogen deposition and of exerting a clinically useful anti-inflammatory effect.

**Hematoma** - a localized mass of extravasated blood that is relatively or completely confined within an organ or tissue, a space, or a potential space; the blood is usually clotted, and depending on how long it has been there, may manifest various degrees of organization and decolorization.

**Hepatic** – relating to the liver.

**Hyperbaric** – pertaining to pressure of ambient gases greater than one atmosphere.

**Hypoxia** – decrease below normal levels of oxygen in inspired gases, arterial blood, or tissue, short of anoxia.

**Ischemia** – diminished blood supply to an area of tissue causing a decrease in the delivery of oxygen and nutrients.

**Macrophages** – an actively phagocytic cell arising from monocytic stem cells in the bone marrow.

**Necrosis** – pathologic death of one or more cells, or of a portion of tissue or organ, resulting from irreversible damage.

**Neutrophils** – a mature white blood cell in the granulocytic series, formed by myelopoietic tissue of the bone marrow, and released into the circulating blood, where they normally represent from 54% to 65% of the total number of leukocytes.

**Pathogens** – any virus, microorganism, or other substance causing disease.

**Percutaneous** – denoting the passage of substances through unbroken skin.

**Perfusion** – the act of forcing blood or other fluids to flow from the artery through the vascular bed of a tissue or to flow through the lumen of a hollow surface.

**Phagocytosis** – the process of ingestion and digestion by cells of solid substances, other cells, bacteria, bits of necrosed tissue, foreign particles.

**Platelets** – an irregularly shaped disk-like cytoplasmic fragment of a megakaryocyte which is shed in the marrow sinus and subsequently found in the peripheral blood where it functions in clotting.

**Proliferative** – increasing in the number of similar forms.

**Venous stasis** – stagnation of the blood or other fluids in the veins.



## 5. HARDWARE AND SOFTWARE DESCRIPTION FOR pH ACQUISITION

During this research, tissue pH measurements are taken using a hardware system, micro-combination glass electrodes, and a custom-made software program. George Gumbrell designed the hardware as a part of a master's thesis completed at WPI [40]. Because it is an integral part of the acquisition of pH signals, the hardware design will be described briefly in the following sections. The developed software program and supporting algorithms will also be discussed. In this research, we are concerned with tissue pH measurements; thus, the software algorithms that were developed will take into consideration issues specific to this area of study. This chapter aims at describing the hardware and software that is used to acquire the pH data. Subsequent chapters will detail how the pH data is analyzed and correlated to the location of measurement and other properties of the wound.

### 5.1 Hardware Description

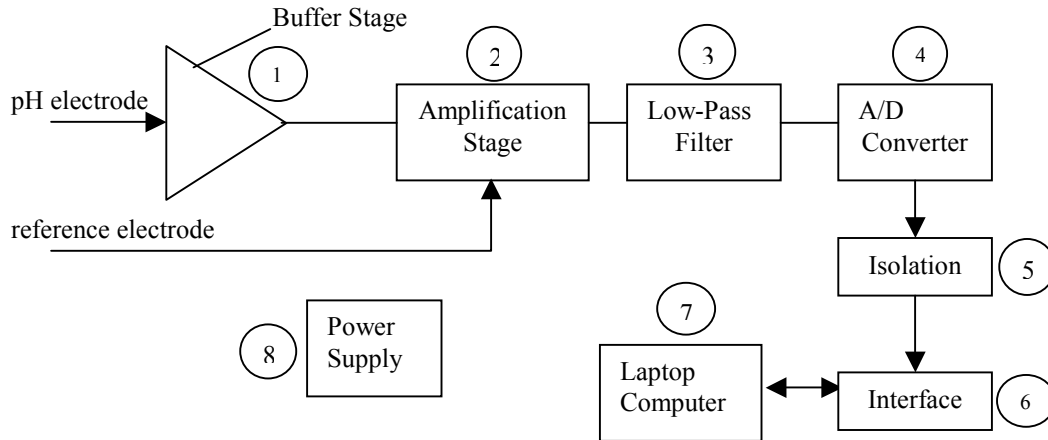
The apparatus consists of a laptop that is fastened to a docking station, which contains the hardware. The system's hardware is responsible for preprocessing and converting the analog pH signal to digital format before being analyzed by the software program. The side of the docking station contains ports for the MI-414 electrodes to be attached by BNC connectors.

The hardware has three major components: the analog, digital, and isolation sections. The analog section processes the analog pH signal by multiplexing, amplifying, and filtering the signal generated by the electrode. The digital section begins with the A/D converter which converts the analog signal to a digital form. This section also includes the laptop which interfaces to the hardware circuits. The isolation section provides electrical isolation between the patient and the digital section of the system to ensure that safety standards are met [40].

#### 5.1.1 Hardware Operation

Figure 5.1 shows a block diagram of the portion of the tissue pH monitor that is used in this research. Seven major stages are utilized to read the signal from the electrode, digitize the analog information, and communicate between the hardware and software. Each stage is critical to the accurate attainment of a tissue pH signal. Following is a brief description of each of these stages:

1. *Buffer Stage* - A voltage that is proportional to the pH of the solution in which the electrode is submerged is produced by an electrochemical reaction. This voltage then enters the buffer stage which transforms the high impedance source signal into a low impedance signal. The amplifier that is used in this stage has an input impedance of at least ten times greater than the output impedance of the pH electrode [40]. This prevents current loading of the electrode. This stage also allows for the selection of one of the two active pH electrode channels, so that monitoring of two different tissue samples can be achieved. The two-channel feature will not be utilized because one-channel point measurements are sufficient for this research.
2. *Amplification Stage* – This stage increases the input voltage, without



**Figure 5.1: Block diagram of the hardware configuration of the system [40]**

amplifying any noise that may plague the signal. Therefore, the signal-to-noise ratio is increased as a result of this amplification. The instrument is set up to produce a gain of 14.7 [40]. This gain allows for high resolution of the pH signal. The signal from the reference electrode is input into this stage and is compared to the output of the buffer stage to produce a differential signal.

3. *Filter Stage* – A second order Butterworth low-pass filter is utilized to eliminate low-frequency noise, such as the 60 Hz power noise. The filter is designed to have a 1 Hz cutoff frequency. Therefore, frequencies between DC, including the pH signal, and 1 Hz are passed to the next stage. Frequencies above 1 Hz are attenuated.

4. *A/D Converter* – This stage converts the analog signal to digital information. The A/D converter must have low noise and low supply current and a substantial number of output bits to provide sufficiently high resolution of the voltage signal [40]. This high resolution is important because small changes in voltage correspond to significant changes in pH. A 12-bit A/D converter was chosen along with a high precision reference chip, which is needed because the A/D converter does not have an internal voltage reference.

5. *Isolation Stage* – An isolation stage is necessary to electrically isolate the patient from the computer and ground [40]. To minimize the power consumption, a low power isolation chip was chosen for this stage.

6. *Interfacing* – The software is set up to control the hardware. Each hardware component that is connected to the computer has a numerical address (300 hex to 30F hex) that the computer uses to access it. Sixteen address lines are connected from the IBM address buss to the hardware allowing for access to the system by commands written in the software program.

7. *Laptop Computer* – The computer is mounted on the docking station which contains all of the hardware. The computer is the platform for the software program which controls the actions of the hardware. Its memory capacity is also used to store data.

8. *Power Supply* – An isolated power supply, consisting of a DC to DC converter,

generates  $\pm 5$  V supply voltages for the analog stages of the system [40]. Additionally, a + 5 V power supply comes from the docking station/laptop computer. The DC to DC converter that was chosen is a 1.0 watt, regulated, medical isolated, low noise converter [40]. The laptop computer/docking station combination is also set up to run from the laptop's battery if necessary, but the battery life (1.5 hours) is unacceptable for the purpose of this research.

## 5.2 Software Design

The software was developed on a Windows platform using LabWindows software. The program aids in accurately acquiring a voltage signal from the hardware and interpreting this signal into a pH level that corresponds to a given area of tissue. An offline software program will be used to analyze the acquired pH data as it relates to the tissue's properties, i.e. bacterial contamination, appearance, and location. This program will be explained within the chapters on methods. Thus, the main purposes of the LabWindows software program are as follows:

- control the actions of the hardware for data acquisition;
- provide a user interface that can be easily followed; and,
- allow for experimental data to be saved for offline analysis.

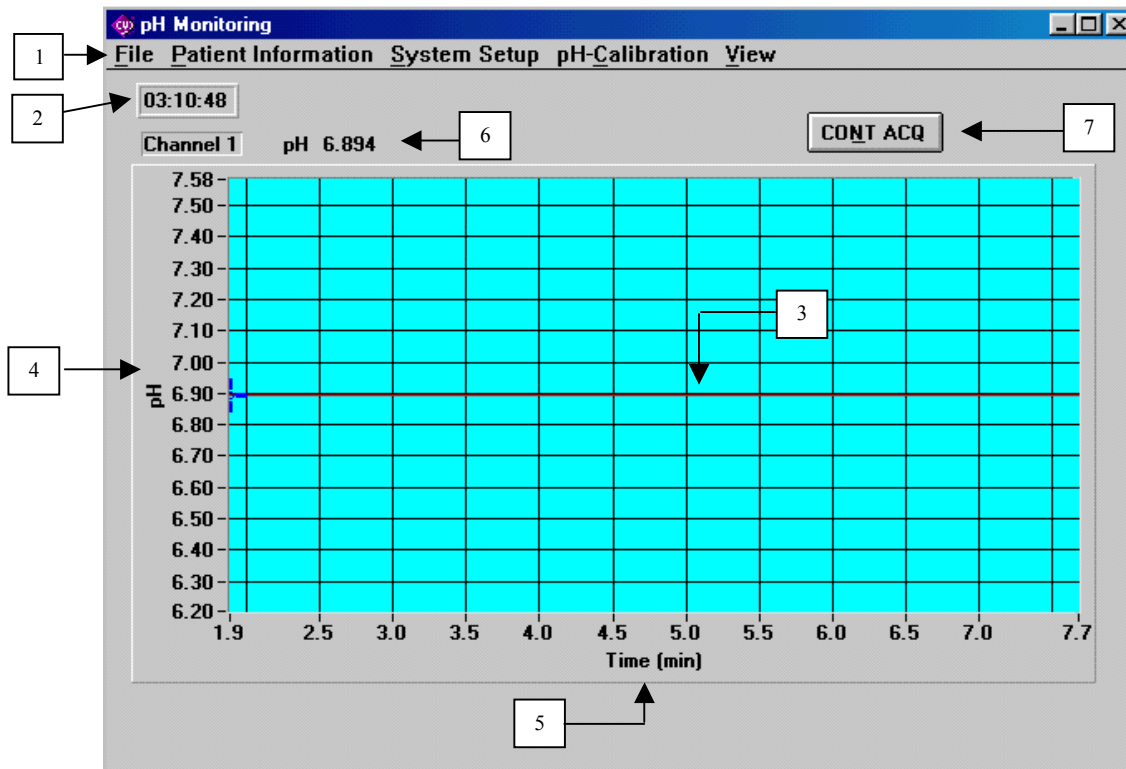
These three capabilities aid in making the instrument easy to operate and alter according to the needs of the research. The software program controls the hardware which reads in a signal from the electrode. This signal is analyzed by the program and saved to an output file. The user interface contains step-by-step instructions, making the system's capabilities easily understandable. The program is menu driven, allowing the user to select each component of the software program from a drop down menu. These components are explained in the following sections.

## 5.3 Graphical User Interface

The user interface allows for easy operation of the software program, which controls the hardware system. The main window of the software program can be seen in Figure 5.2. This window has several features, including the main menu from which all the software's capabilities can be accessed. The major components of the main window are described in the following numbered items, which correspond to the numbers in Figure 5.2:

1. *Main Menu*: Each of the software's features can be accessed by clicking on one of the following menu options: *File*, *Patient Information*, *System Setup*, *pH-Calibration*, or *View*. The *File* menu option controls the main window. It allows the user to shut down the program by selecting *exit*. The remaining menu options are more involved and will be described in subsequent sections.
2. *Digital Clock*: The clock obtains the current time from the laptop's clock.
3. *pH Monitoring Graph*: This area displays a continuous signal which represents pH levels of the environment to which the current electrode is exposed. The blue cross is a marker that can be placed at any point on the pH signal, by a click of the mouse, to determine the value of an instantaneous measurement (refer to item number 6).

4. *Y-axis*: The y-axis displays pH units which are calculated from the electrode's



**Figure 5.2 Main Window of the pH Monitoring Program**

previously determined calibration characteristics. The y-axis range is continually adjusted to ensure maximum resolution of the current pH signal.

5. *X-axis*: The x-axis displays the time stamps of the pH signal in minutes.
6. *Instantaneous pH*: This display shows the pH of the signal at the position of the blue cross. This feature is helpful in determining maxima and minima in a given pH signal recording.
7. *Continuous Acquisition*: Pressing this button will begin the continuous pH monitoring. When monitoring is engaged, a STOP button will appear which can be used to terminate the monitoring session. The CONT ACQ button will then reappear and monitoring can be restarted at anytime, yet the time on the x-axis will always be in relation to the initial starting time of the monitoring session.

The pH monitoring feature of this program is often used to check the proper operation of the electrode and its calibration characteristics immediately before testing begins. This allows for any faults in the electrode's behavior to be determined and resolved before testing. Sections 5.3.1 through 5.3.4 describe the elements of the program that can be enabled by using the main menu options.

### 5.3.1 Patient Information

If the users select the *Patient Information* menu option, they can then select *view* (see Figure 5.3). This action will bring up a new window, which can be seen in Figure 5.4. The following information about the patient can be entered into the window:



**Figure 5.3: Patient Information menu option**

1. *Patient Code*: This will identify the patient as a number, keeping his/her identity confidential.
2. *Patient Age*: The patient's age is one of the extrinsic factors that affects the proper healing of a chronic wound.
3. *Age of Wound*: The wound's age is entered in terms of months from its first appearance.
4. *Gender*: This information is used for descriptive purposes.
5. *Race*: This optional piece of information is also for descriptive purposes.
6. *Description of Wound*: Within this field, the user may input information about the wound's cause, type, location, appearance, etc. The purpose is to possibly relate the data found during testing to the wound's qualitative characteristics.

**Figure 5.4: Patient Information Window**

7. *Notes*: Any additional information that may be pertinent to the case can be placed here.
8. *Open, Save, and Cancel*: The user can Save or Cancel the information he/she has input into the window. The patient information will be saved as a .txt file, titled by the patient code. The user can also open existing files to view and/or modify them.

The patient window serves the purpose of recording information about the patient and about the characteristics of the patient's wound. These pieces of information are very important in assessing any relationships between the quantitative and qualitative data surrounding the patient's medical situation.

### 5.3.2 System Setup

The system setup option, as seen in Figure 5.5, is used to access the pH Probe Setup window. This window has fields in which the user can input the calibration characteristics of the electrode that is currently attached to the system. If the user has calibrated the current electrode, the calibration characteristics will automatically appear in the pH Probe Setup window. In this case, the *System Setup* menu option can be used to view and record the characteristics.

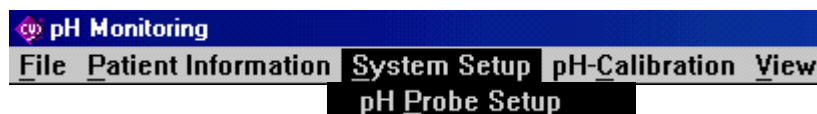


Figure 5.5: *System Setup* menu option

### 5.3.3 pH-Calibration

Selecting the *pH-Calibration* menu option (see Figure 5.6) will bring up three different items from which to choose. The *load* option allows for the user to load previously saved calibration characteristics. The *save* option allows the user to save the calibration characteristics of the electrode that was calibrated most recently during the current session of the program. The *two-point calibration* option begins the calibration process.

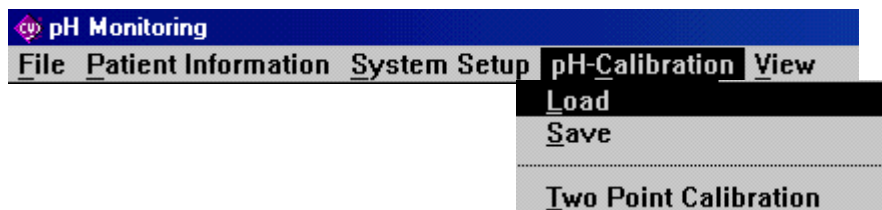


Figure 5.6: *pH-Calibration* menu option

The electrode that is being calibrated should be placed in the buffer solution that is the more acidic of the two buffers that will be used for the two-point calibration. The user will be prompted to tell the program whether the electrode is ready for calibration. Once the calibration setup is finalized, the Enter key can be pressed and the window seen in Figure 5.7 will pop up. In this window, the user will input the value of the first pH buffer, here 6.0 pH units. Once the OK button is selected, measurements will be taken from the electrode.

The measurements are displayed in millivolts in a new window, which can be seen in Figure 5.8. The mV reading is the actual voltage level that the hardware registers from the electrochemical reaction that takes place between the electrode and the buffer solution.

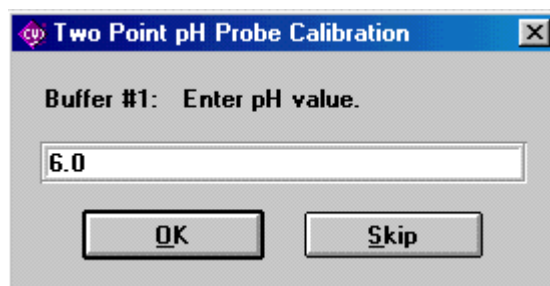


Figure 5.7: First step in the two-point calibration process

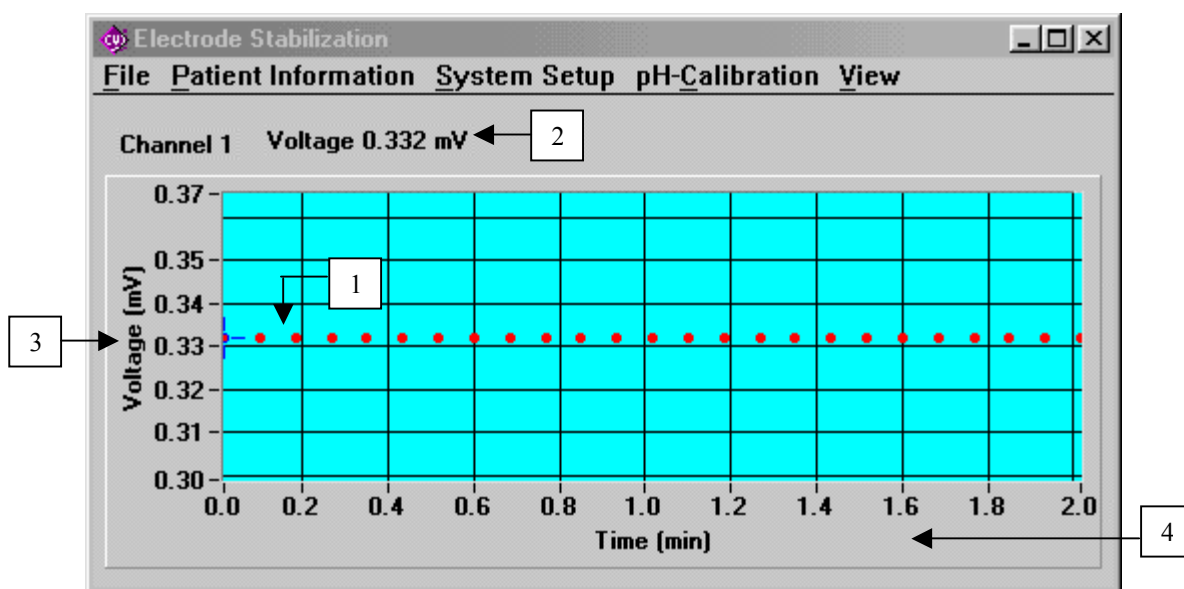


Figure 5.8: Electrode Stabilization Window used in the Calibration Process

The components of Electrode Stabilization window are as follows (corresponding to the numbers in (Figure 5.8):

1. *Electrode Output*: This graph displays the voltage values that are recorded from the electrode's reaction with the buffer in which it is submersed.
2. *Instantaneous Measurement*: This display shows the value of the most recent measurement in millivolts. This feature helps to determine the difference in consecutive measurements.
3. *Y-axis*: Displayed in millivolts, this axis will change continuously to attain the highest resolution.
4. *X-axis*: Displayed in minutes, this axis records the time at which the current measurements are being taken, relative to the starting point at time zero.

Measurements are taken for two minutes. At this point the user is asked to view the sequence of voltage levels and determine if the electrode has stabilized. If the user

answers YES to the question of stabilization, the window seen in Figure 5.7 reappears and the next pH buffer value must be entered. Subsequently, the same process of taking measurements and determining the electrode's stabilization occurs again.

If the user replies NO to the question of electrode stabilization, then a couple more measurements will be taken and displayed on the same graph as seen in Figure 5.8. The user will then again be prompted to answer whether the electrode has stabilized. This sequence of events will continue until the user informs the program that the electrode has stabilized. It is critical that the user takes great care in judging whether the electrode has stabilized because the final voltage that is recorded for each of the buffers is used to determine the calibration characteristics, which affect all future measurements taken with that electrode.

When the calibration process has finished, a window will appear that displays the voltage level that corresponds to each of the buffers as well as the slope and intercept of the calibration line that was calculated from these voltages and pH levels. These values are automatically entered into the pH probe setup window and all subsequent measurements during this session will use the calculated characteristics. Once the electrode is calibrated, the system is ready for attaining pH measurements.

#### 5.3.4 View

Selecting the *View* menu option (see Figure 5.9) will bring down two items from which to choose. The *single pH acquisition* menu item can be used to determine an instantaneous voltage reading resulting from the reaction between the electrode and the solution with which it is in contact with at the time. A new window will appear in which the voltage will be displayed graphically and as a value, in millivolts. A button, titled ACQUIRE, can be pressed to reacquire the voltage.

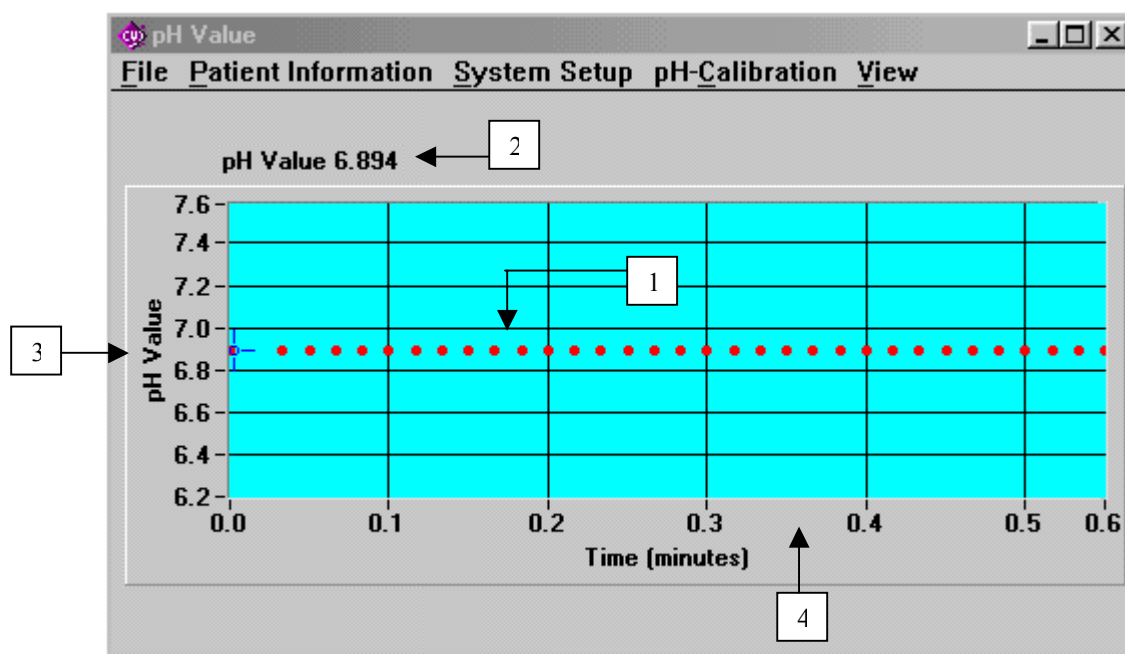
This feature is not used often but is helpful in checking the accurate operation of the electrode and the previously calculated calibration characteristics. A voltage within a known range should be read from the electrode for a given pH. For example, if the electrode is submersed in a 7.0 pH buffer and a single pH acquisition results in a 100 mV reading, it is very likely that the electrode is faulty. This is because the electrode's characteristics typically intercept the x-axis near 7.0, making the millivolt reading at this pH close to zero. This feature can also be used for one-point calibration, which will not be used in this research.



Figure 5.9: *View* menu option

The *pH imaging* option is used during testing to acquire tissue pH measurements. If calibration characteristics have not been entered before this option is selected, the user will be reminded that calibration must first be performed. Once this has been accomplished and the electrode is prepared to measure, selecting this option will bring up a new window as seen in Figure 5.10.



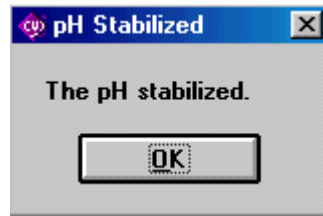


**Figure 5.10: pH Imaging window**

The user will first be prompted to place the electrode in the first measurement position. Once this is done, the system will begin recording pH measurements and displaying them on the graph (Figure 5.10), which has the following elements:

1. *pH Measurement Graph*: This graph displays the pH value of the solution that is in contact with the current electrode. This value is calculated by using the calibration characteristics that are displayed in the *pH probe setup* window.
2. *Instantaneous pH Value*: This display shows the most recent pH value that has been recorded. This is helpful to visualize small changes in the pH level.
3. *Y-axis*: Displayed in pH units, this axis is continually adjusted to allow for the maximum resolution.
4. *X-axis*: Displayed in minutes, this axis contains the time stamp for the pH recording.

After a predetermined amount of time for initialization of the measurement, the software program verifies whether the electrode has stabilized, meaning that the measurement points have not greatly deviated from the current values within the last ten to fifteen seconds. If the pH measurement is stable, the window displayed in Figure 5.11 will appear and the system will be ready for the next measurement point. If the pH does not stabilize in one and half minutes, another window will appear that informs the user of this fact. The user must then determine whether he/she wants to continue measurements in the current position or terminate the current measurement and move to the next point. In either case, a final pH value is determined for each point measurement. The algorithms used for these calculations will be explained in the next section.



**Figure 5.11: Stabilization Notification Window**

This portion of the program simply acquires the pH values for a given testing point and saves the pH signal and the final value to a file. Due to stabilization issues which will be discussed in the next section, pH values are acquired from one point for up to one and a half minutes. The resulting signal is used to determine a pH level for that point. The software program labels each point by a measurement number and writes all the pertinent information to an output file (see section 5.4.3). The user must record the locations in the wound to which the measurement points correspond. The chapter on methods will explain how this is done for animal and clinical testing and how the pH data points, their location, and the wound's properties will be analyzed together.

#### **5.4 Algorithm Development**

Several algorithms were developed to acquire and process the pH data. As discussed in the hardware description section, calling specific addresses through a port that connects the laptop to the system accesses the hardware. Once the appropriate address is called, the software reads the bits from the A/D converter and translates them into a decimal value (commonly called machine units). This decimal value is stored and is manipulated to determine the pH level of the reading. Once this pH value is calculated, it must be analyzed. Algorithms were developed which determine the stabilization of the pH signals by real-time analysis of the measurement points.

##### **5.4.1 Calculation of pH**

Once the decimal value of the machine units is determined and assigned to a variable, the millivolt level that this value corresponds to can be calculated. This is done by first checking the fifth bit, attained from the A/D converter, to determine the sign of the voltage. The machine units are then converted to a voltage and normalized by the gain of the hardware, which is 14.7 units. The pH produces small voltages, so the value is multiplied by 1000 to convert it to millivolts.

The voltage level is then converted to pH units using the previously determined calibration characteristics. This is done through the following sequence of events. Five consecutive voltage levels are read in by registering the bit sequences from the hardware and converting them to millivolts. An average of these five measurements is then calculated. This voltage level is converted to pH units by using the following equation:

$$\text{pH\_value} = (\text{voltage/slope}) - \text{intercept} \quad (5.1)$$

The slope and intercept are calculated during calibration and are specific to the current electrode. The calculation results in the pH level of the solution with which the electrode is in contact. Immediately following this calculation, the software checks if the

pH level is less than zero or greater than fourteen. If this is true, an error has occurred which may be due to miscalculated calibration characteristics, hardware/software problems, or improper electrode operation. The software will notify the user that such an error has occurred, but the user must determine its origin.

#### 5.4.2 pH Stabilization Algorithm

During the attainment of tissue pH measurements, it is important to determine whether the measurement has stabilized. Due to the non-uniform properties of tissue, the electrode will not stabilize to a voltage level as quickly as it would if it were placed in a buffer of constant pH. The pH will move towards a certain region in the zero to fourteen pH range, yet it will not remain constant at first. The values may jump within a 0.2 pH interval due to the tissue's properties and changes in the pressure that the user applies to the electrode. For these reasons, an algorithm was developed to automate the determination of the electrode's stability when measuring tissue pH.

Once calibration has been performed and the slope and intercept of the characteristics have been saved in the appropriate variables, the electrodes may be used for pH measurements. When the *pH imaging* item is selected from the *View* menu option, numerous isolated points can be measured and will be saved to a text file. When the user tells the software that the electrode is ready for measurement, the pH of the current environment will be calculated as explained in the previous section. Figure 5.12 shows the code that determines whether the measurements obtained from the electrode have stabilized enough to attain an accurate pH level.

```

1  if(timer > 30)                /*don't enter loop during initial
                                measurements*/
2  {
3    for(j=k-10; j<k; j++)
4      sum += save_pH[j];
5
6    avg = sum/10;                /*calculate the average of the
                                last 10 samples*/
7
8    for(j=k-10; j<k; j++)
9    {
10     diff = save_pH[j] - avg;
11     if(diff < 0)
12       diff = diff*-1;
13     mad += diff;
14   }
15   mad = mad/10;                /*calculate the MAD of the
                                last 10 samples*/
16

```

```

17  if(mad < 0.008)                /*if the MAD is less than
                                     0.008 pH units, the signal
                                     has stabilized*/
18  {
19      sel = MessagePopup("pH Stabilized", "The pH
                                     Stabilized.")
20      image_value[x_point] = avg; /*save average as the
                                     final value for this
                                     reading*/

21  }
22  }

```

### Figure 5.12: Code that checks for stabilization of the tissue pH signal

Line 1 of the code indicates that the first thirty counts of the timer are used for initialization of the electrode to the environment on which it is placed. Thirty counts of the timer is equivalent to thirty-six seconds because the signal is sampled at 1.2 seconds/sample. After this amount of time, this loop of code can be accessed. Lines 3 through 6 average the ten most recent pH measurements. Lines 8 through 15 calculate the mean absolute deviation (MAD). This is a statistical measure that calculates the mean distance of the measurement points from the average of these points. The formula for the MAD is as follows:

$$\text{MAD} = [1/(n-1)] \sum |y_i - y| \quad (5.2)$$

where  $n$  is the number of samples,  $y_i$  is the  $i^{\text{th}}$  sample and  $y$  is the mean of the  $n$  samples. The absolute value of the current sample minus the mean is summed for all  $n$  samples and divided by the mean's degrees of freedom,  $n-1$ .

Once the MAD is calculated for the ten most recent samples, a threshold must be checked to determine if the average distance of the samples from the mean is small enough to indicate stabilization. This threshold is set at 0.008 as seen in line 17 of the above code. The threshold was determined by analyzing data from preliminary animal studies. The signals from these preliminary studies were input into Excel. The algorithm that appears in Figure 5.12 was recreated in Excel and the threshold that best determined stabilization of the pH signals was chosen. Thus, if the average distance from the mean for the last ten samples is less than 0.008 pH units, the electrode measurements have stabilized. Line 19 produces a message that tells the user that the pH has stabilized. Line 20 saves the average (from the last ten samples) to a variable, which will be written to an output file.

If one and a half minutes pass without stabilization, the program will produce a window that states that the pH measurements do not appear to be stabilized. At this point, the user may indicate that more measurements should be taken or that the average that the program computes is acceptable. If additional measurements are opted for, the algorithm is initialized, and the check for stabilization begins as previously explained.

If the user decides that the pH measurement is not going to stabilize by the algorithm's standards, a new algorithm (see Figure 5.13) is used to determine an appropriate average that can be used as the pH value for that measurement.

```

1  if(flag != 1)          /*enter this loop if the signal did
                           not stabilize before one and a half
                           minutes*/
2  {
3      sel = MessagePopup ("pH Meaurement", "The pH did not
4          stabilize.\n An average will \n be calculated.");
5
6      sum = 0;
7      for(j=k-20; j<k; j++)
8          sum += save_pH[j];
9
10     avg = sum/20;      /*calculate the average of the last
                           20 samples*/
11
12     for(j=k-20; j<k; j++)
13     {
14         diff = save_pH[j] - avg;
15         if(diff < 0)
16             diff = diff*-1;
17         mad += diff;
18     }
19     mad = mad/20;      /*calculate the MAD of the last 20
                           samples*/
20
21     fprintf(file, "The pH did not stabilize so the
22         acceptable values in\n the last 20 samples will be
23         averaged.");
24     fprintf(file, "average %.2f mad%.2f", avg, mad);
25
26     sum = 0;
27     count = 0;
28     for(j = k-20; j<k; j++)
29     {
30         if((save_pH[j] < avg && save_pH[j] > avg - mad) ||
31             (save_pH[j] > avg && save_pH[j] < avg + mad))

```

```

31     sum+= save_pH[j];    /*only sum samples that are
                           within the MAD*/
32     count +=1;
33 }
34 avg = sum/count;      /*average the summed values*/
35
36 image_value[x_point] = avg; /*save average as the
                               final value for this
                               reading*/
37 }
38 }

```

**Figure 5.13: Code that calculates an average for a signal that did not stabilize**

If one and a half minutes have passed, the pH signal will be declared unstable. The flag variable in line 1 of Figure 5.13 will be set to 1 if the signal has stabilized; in that case, this loop will not be accessed. Otherwise, the software must analyze the pH signal and calculate an appropriate pH level for the corresponding point measurement. Lines 6 through 10 in Figure 5.13 compute the average of the last twenty samples. Then, lines 12 through 19 compute the MAD for the last twenty samples. The next step is to use a loop (lines 26 through 37) to check whether each of these twenty samples is within  $\pm$ MAD from the average. The samples that are within this range are summed and averaged. This average is saved as the final value for the signal being analyzed.

The algorithms presented in Figures 5.12 and 5.13 check for stabilization and calculate averages of the pH signals that are good estimates of the actual pH level of the tissue in question. The averaging is necessary because of the nature of tissue pH measurements. Ideally, once the electrode has settled to a certain value that reflects the pH of the tissue, the final value of the signal would be declared the true pH level of the tissue. The tissue's properties and the nature of pH electrodes will not allow for this simplicity, making the software algorithm an essential part of the data acquisition process.

### 5.4.3 Output File

The pH signals are written to an output text file for offline analysis. Each signal is written to the file once the pH acquisition is completed for that measurement point. The signal is labeled by the measurement number, and the time stamp and corresponding pH value are included in the file. Also, a statement is written to the file describing whether the signal has stabilized. The software then calculates a final pH level for the signal based on the MAD (explained previously) and writes these pieces of information to the file.

The same process is performed for as many measurement points as the user would like to measure. Once pH acquisition is completed, a summary of the data points that have been measured is included at the end of the file. The entire signal information for each of the points is included in case the user would like to inspect the nature of the pH signal. This is also beneficial in determining trends in the pH measurements during

preliminary testing. Figure 5.14 displays portions of a sample output file that was recorded during preliminary animal testing.

```
Measurement 1
0.00      6.463
0.03      6.629
0.05      8.439
0.07      7.264
.
.
.
1.33      7.401
1.37      7.430
1.38      7.407
1.40      7.407
1.43      7.389
1.45      7.389
1.47      7.430
1.50      7.418
```

The pH did not stabilize. An average will be calculated.

MAD - 0.27

Final Average - 7.43

```
Measurement 2
0.00      6.950
0.02      7.045
0.03      7.080
0.07      7.104
0.08      7.211
0.10      7.116
.
.
.
```

Measurement Number	pH Value
1	7.4310
2	7.3784
3	7.1628
4	7.4177
5	7.4125
6	7.4492

**Figure 5.14: Portions of an Output File from pH Acquisition Software**

As can be seen, the data points from measurement number one are recorded in the text file with a time stamp (in minutes) and a pH value for each sample of the signal. After 1.5 minutes, the pH signal is proclaimed unstable. An average is calculated (see Figure 5.13) and written to the file because the user opted not to continue measurements of this point. The MAD is recorded in terms of pH units, indicating the variation in the signal. The next point is measured using the same process. Once all of the points were measured, a summary of the pH values was printed to the file. Figure 5.1.4 shows that six points were measured during the acquisition session. This file format allows for the user to understand where the pH levels for each of the measurement points are derived from. It is an efficient way to keep records of all of the data acquired during testing.

### **5.5 The pH Monitoring System**

The hardware and software components that have been described together produce a system that is effective in measuring tissue pH. The software program, placed on a laptop computer, controls the actions of the hardware, which attains signals from the electrodes. The software also contains algorithms that calibrate the electrodes and check for stabilization of the pH signal. The program calculates an average of the measurement points, which excludes outliers, and saves this average as the final value of the corresponding signal. The acquired pH signals are written to an output file along with a summary of the tissue pH values for each point. Thus, the actions of the hardware and software result in a single value for each point measurement. This data will be used to research relationships between tissue pH levels and tissue properties in wounds, specifically bacterial contamination.



## 6. METHODS AND PROTOCOLS

It is very important to carefully develop the methodology used to perform the testing in this research. This essential research step, methods and protocol development, provides the required preparation leading up to the testing portion of the research. This chapter will include the explanation of the procedures used in the research, starting with the testing of the equipment and finishing with the techniques used for data analysis. Each section in this chapter corresponds to a separate section in the chapters on results and discussion. Thus, the methods are used to produce the results that are presented in chapter seven and discussed in chapter eight.

### 6.1 Testing of the MI-414 Electrodes

In this research, MI-414 glass micro-combination pH electrodes, manufactured by Microelectrodes Inc., will be utilized. These electrodes are ideal for this research because they are combination electrodes, meaning that the reference electrode is imbedded in the pH probe. More importantly, the tip of the electrode is small (1.7 mm in diameter) and therefore can read the pH of micro-samples. This is crucial for this research because a limited amount of fluid is present on a tissue's surface. In addition, Microelectrodes, Inc. donated the electrodes, which helps to reduce the cost of the research.

All electrodes theoretically have identical parameters. Realistically, they are very similar. For example, the time that it takes for each electrode to stabilize in a given medium was found to be almost identical for all electrodes. Thus, all tests will be done on a few of the electrodes and an average of these results will serve to represent all of the electrodes. Extensive testing is not needed because analysis of the electrode's properties is not the central aim of the research; although, it is needed to optimize the experimental protocol. Enough testing will be performed to achieve an accurate idea of the electrode's performance in a given area. Statistically sound data is not necessary.

Thus, testing the electrodes is an essential step because the accurate operation of the pH electrodes will dictate whether the pH measurements are correct. Thus, all aspects of the electrodes will be analyzed for the following reasons: 1) to make sure that they are appropriate for our research purposes; 2) to attain a thorough understanding of their operation; and, 3) to gain practice handling and utilizing the electrodes before testing begins.

Several key testing areas were identified based on the manner in which the electrodes will be used. The testing of the electrodes will give us a total understanding of the operation and limitations of the pH electrodes. The following aspects of the electrodes' operation will be tested.

- Time constants – calibration time constant and electrode time response;
- Stability – long term stability and electrode stability while being handled;
- Temperature dependence; and,
- Effects of sterilization.

The methodology used to perform each of these tests will be explained in the following sections.

### 6.1.1 Time Constant Determination

The response of the electrode to different pH solutions is not instantaneous. This is due to the fact that an electrochemical reaction takes place between the electrode and the solution in which it is immersed. When the electrode is placed in a solution, the flow of ions in the electrolyte must readjust as the new electrochemical reaction is introduced. This reaction needs some time to equilibrate. In addition, analog and digital signal processing introduces an additional minimal time delay.

Two different time constants need to be determined to better understand the operation of the electrodes. The first time constant is used in the calibration procedures, and the second is used during measurement of tissue pH at different sites in the wound. The determination of these time constants is necessary to develop the most time-efficient algorithms in the software program of the pH acquisition system.

#### 6.1.1.1 Calibration Time Constant

During calibration of the electrodes, it is important to allow sufficient time for stabilization of the electrode/reference combination. If readings are taken before the electrode has stabilized, the calibration characteristics will not be accurate, and the pH readings that are taken using these characteristics will be inaccurate. The calibration characteristics are therefore the basis for all subsequent measurements. Because of the extreme importance of electrode stabilization, several studies were conducted to determine the minimum time needed to accurately calculate the electrodes' calibration characteristics.

Two electrodes were utilized in this portion of the testing. The software program was altered to graph the computer units that the software is reading from the hardware versus a time axis in order to visualize trends in the electrode stabilization curves. These values were also saved to a text file to be later analyzed. The following procedure was used to collect the data:

1. Place three test tubes in a tray and fill each with one of the following solutions: 6.0 pH buffer, 8.0 pH buffer, and distilled water.
2. Place the electrode in the distilled water.
3. Lift the electrode from the water and begin the calibration as the electrode is lowered into one of the two buffer solutions routine (see section 6.2 for an explanation of the calibration procedure).

Using this method, the initial recorded voltages are a result of the electrode being exposed to the air. The electrode is then submersed into the first buffer, and it is allowed sufficient time for stabilization. The process is stopped when, by viewing the graph of computer units versus time on the laptop screen, it is obvious that the voltage reading has stabilized. This process is repeated for the second pH buffer and repeated for two more trials. The entire process is then repeated for another electrode to ensure that the results are reproducible and representative.

### 6.1.1.2 Electrode Time Response

The time that it takes for the electrode to respond and stabilize when introduced to a new medium is an extremely significant parameter in this research. During the clinical testing stage of the research, several tissue pH measurements will be made on patients with chronic wounds. Because the time spent with the patient should be kept to a minimum, the time used for testing must be as efficient as possible. One of the factors that may lengthen the process is the time response of the electrode to variations in pH. Although the manufacturer claims that the response time of the electrodes is within fifteen seconds, they have not performed extensive testing with our pH meter. Thus, tests were performed to determine how fast the electrode and system register changes in pH. The change in pH per unit time that the electrode reads when it is initially immersed in a solution is noted. The determination of this time constant is important because the software program can be designed to allow the electrode to stabilize without using excessive amounts of time.

Two different electrodes were tested to ensure reproducibility of the results. Each of the electrodes was first calibrated, and then the “pH monitoring” feature of the software program was utilized to measure different buffers. Three pH buffers of 8.0, 7.0, and 6.0 pH units were used. The procedure for this portion of the testing is as follows:

1. Place electrode in pH buffer #1.
2. Begin pH monitoring.
3. Place the electrode in buffer #2 and allow for stabilization.
4. End pH monitoring.
5. Repeat steps one through four for different combinations of pH buffers.

Each of the results was analyzed and four parameters were identified as follows: 1) time of initial drop in pH; 2) time of gradual stabilization of the pH; 3) percentage of the final pH reached after the initial drop in pH; 4) average drop and rise of pH (pH/s). The results were averaged for each of the electrodes tested and compared to determine if any outliers were present. Determination of these parameters will give a thorough understanding of the behavior of the electrode when it is transported from one medium to another.

### 6.1.2 *Stability Tests*

The stability of the electrode will affect the readings that are recorded by the monitoring system. Thus, two tests for stability were performed. The first was a long term test to determine the trends of the electrodes' performance over time. A small amount of drift is inherent in the electrodes, and it is important to determine if this drift will affect the testing being done in this research. The second test is for the stability of the electrode when being held. During testing, the electrode will be held, and minor movements are unavoidable. It must be determined whether these movements will greatly affect the pH level recorded by the monitoring system.

### 6.1.2.1 Long Term Stability

Although this research does not involve long term monitoring of pH, it is important to determine the long term characteristics of the electrodes for several reasons. The results of the long term tests may or may not show that the results achieved in Gumbrell's thesis work are reproducible [4]. The instrument developed during that research is being utilized for testing of the MI-414 electrodes, and many of Gumbrell's methods have been referenced in this research. In addition, a significant change in pH over time may be a result of factors other than instrument drift, as discussed in Gumbrell's thesis [4]. If a significant amount of drift is apparent, it may even affect the accuracy of the electrode during the testing period. Thus, long term tests are warranted.

The procedure for these tests is as follows. The pH buffers were set up in a water bath adjusted to 38° C to simulate the temperature of the human body. A calibrated electrode was then placed in a buffer solution and the top of the test tube was sealed with cotton and aluminum foil to decrease the amount of evaporation of buffer solution over the time of the long-term test. The test tube and electrode were then placed in the water bath. pH monitoring started when the temperature of the pH buffer reached 38° C. Once pH values were being recorded, the apparatus was checked periodically to ensure that the temperature was stable and all other components of the setup were operating correctly. Two long-term studies were conducted to ensure reproducibility of results.

### 6.1.2.2 Stability while Holding the Electrode

The most important part of this research is collecting data during animal and clinical trials. During these trials, the pH will be recorded by manually holding the electrode to the animal's or patient's tissue surface. The electrodes contain a small glass bulb at the tip making them extremely fragile. A movement of the hand during measurement of tissue pH may adversely affect the recorded pH. This movement may cause a change in the electrochemical reaction between the tissue and the electrode or the electrode might be exposed to air. Both of these properties may cause a reading that does not reflect the tissue's true pH level.

Thus, tests were performed before animal and clinical trials were begun, to practice holding the electrode with minimal movement and to determine the average variation in measured pH due to involuntary movements of the arm. This test looks at the researcher's stability and the amount of movement that the electrode can tolerate without resulting in major variations of the recorded pH. In an attempt to simulate the environment that will be encountered during testing, a sponge was saturated with a pH buffer and the electrode was held to the surface of the sponge. Although this is not an exact model of measuring tissue pH, it is more realistic than immersing the electrode into a buffer, which produces an ideal reaction between the glass electrode and the ions in the solution.

Five trials were performed for each electrode. The procedure is as follows:

1. Allow the electrode to stabilize in the buffer saturated sponge.
2. Hold the electrode against the surface of the buffer saturated sponge.
3. Record pH values for approximately two minutes.
4. Repeat steps 1 through 3 using the other hand.

Holding the electrode with each hand was tested to determine if one hand consistently produced better results than the other. This test was performed at room temperature because the variations in pH are independent of temperature. Again, the setup for this test is not an exact simulation of the environment in which pH will be measured during testing. In the animal and clinical trials, only the tip of the electrode will be in contact with the tissue fluids, which may be minimal. Issues that arise during actual testing will be addressed at the beginning of the animal studies. The purpose of the current bench test is to determine if any significant changes in pH occur due to involuntary movements of the arm or hand.

### 6.1.3 Temperature Dependence Tests

It has been proven that temperature affects the pH level of a given medium. On the label of the pH buffers manufactured by *Fisher Chemical*, a chart is provided that lists the pH level of the buffer at various temperatures. The buffers have a given pH value at room temperature (approximately 25° C), yet the pH of the buffer varies with changes in the buffer's temperature. Another issue is the temperature at which the calibration will be performed.

A vital concern is that if the temperature in the wound varies from 37° C, then the pH reading may be inaccurate. This is the motive for testing the temperature dependence of the electrode reading within a given range. The test for temperature dependence involved first calibrating an electrode at 37° C, and then measuring the pH of a given buffer while varying the temperature of the buffer by using a water bath. The range of temperatures that are tested are those that can be typically found on a wound (33°- 41°C). The procedure is as follows:

1. Calibrate the electrode at 37° C.
2. Set the temperature in the water bath to 41° C.
3. Place a calibrated electrode into a buffer in the water bath.
4. Begin recording of the pH.
5. Shut off the water bath heating.
6. Record the temperature and pH for various times throughout the test.
7. Stop the test when the water bath reaches 33° C.

The pH values versus the temperature were analyzed to determine the variation of pH with changes in temperature. This graph was compared to the manufacturer's values of pH dependence on temperature to determine if the MI-414 pH electrodes recorded similar variations in pH with changes in temperature.

Because the testing in this research involves using the electrodes at body temperature, calibration would ideally be performed at 37° C. The manufacturer provides the pH of the buffer at various temperatures within  $\pm 0.01$  pH units. Using linear interpolation, the value of the buffers at 37° C are calculated and used in the calibration procedure. One of the questions that needs to be answered is the following: does it make a significant difference if the electrodes are calibrated at room temperature for this application? Calibrating at room temperature would simplify the process because a water

bath would not be needed to heat the buffers before calibration is performed. To answer this question, two of the electrodes were calibrated at room temperature and then at 37° C. The differences in the calibration characteristics, calculated for each of the two temperatures, were analyzed. These studies were performed to assess whether changes in the temperature of tissue pH will greatly affect the accuracy of the measurements.

#### **6.1.4 Effects of Sterilization on Electrode Characteristics**

It is required that the electrodes be sterilized before patient testing. This practice complies with hospital and FDA regulations on the handling of hospital equipment. As is standard for equipment that comes into contact with patients at the hospital, the electrodes will be sterilized by application of ethylene oxide. The electrodes are sensitive to temperature; thus, autoclaving or other high temperature sterilization procedures were ruled out and gas sterilization was deemed appropriate. Sterilization by ethylene oxide is done at a relatively low temperature, and ethylene oxide is sufficient in killing bacteria and other foreign substances that may be present on the pH electrodes.

Testing was performed on the electrodes to determine if sterilization by ethylene oxide would harm the MI-414 electrodes. These electrodes have never been utilized in the clinical environment, and the manufacturer could not provide information on the effects of sterilization on the electrode operation. Thus, initially two electrodes were sterilized at UMMC's Central Sterile Area to determine if the electrodes were operational after the sterilization procedure.

The second reason for performing sterilization tests is to see if the gas sterilization greatly effects the calibration characteristics and if there are any patterns in the change of the calibration characteristics. From work done during Gumbrell's research, it was hypothesized that the calibration characteristics will change due to the increased temperature used during ethylene oxide sterilization (55° C) [4]. To test the effect of this process on the MI-414 electrodes, the following procedures were followed:

1. Calibrate the electrodes using the two-point calibration.
2. Gas sterilize the electrodes at UMMC's Central Sterile Area overnight.
3. Recalibrate the electrodes to determine if a change in the calibration characteristics occurred.

These steps were followed repeatedly for several of the electrodes to determine if a pattern could be revealed in changes that may occur in the electrodes' calibration characteristics. It would be beneficial if a definitive trend in the change of the characteristics could be recognized so that calibration did not have to be done after sterilization. If calibration needs to be performed, all materials used in the procedure must also be sterile. These tests will give us a complete picture of how ethylene oxide sterilization affects the pH electrodes. This will also give the manufacturer some invaluable information for future customers who wish to incorporate sterilization into their use of the MI-414 electrodes.

## **6.2 Calibration of Electrodes**

Calibration of the MI-414 electrodes is a crucial step in this research. Several factors must be taken into consideration, and the conditions must be ideal for the

determination of the accurate calibration characteristics. Each of the factors that must be considered, and the procedures that are followed for calibration will be discussed here.

During the testing of the electrodes, several parameters were determined which apply to the calibration procedure. The most crucial parameter is the minimum time required for the electrodes to stabilize during calibration. The voltage level that registers for a given buffer solution does not instantaneously appear on the user interface of the device. The cause of this apparent time delay is twofold: 1) the adjustment of the electrode to the concentration of hydrogen ions in the current solution; and, 2) the time delay of the hardware/software configuration. The hardware was designed and tested in previous research [4]. The software contains minimal filtering; thus, the hardware/software configuration does not contribute significantly to the time delay of the signal.

Therefore, the electrode's reaction to a given medium is the major contributor to any time delay experienced in reading a pH level. To minimize the time delay due to the electrode adjustment, the electrodes are preconditioned in a buffer of 4.0 pH units. Then, before measuring is begun, the electrodes are dipped in a 7.0 buffer and then a 4.0 buffer repeatedly for about five seconds each to exercise the probes. This technique is suggested by the manufacturer.

### **6.2.1 Calibration Procedure**

The calibration process is critical to the accurate operation of the electrode and instrument combination. The calibration of the electrodes should be performed before each use. Although, theoretically, the calibration characteristics should not change, the MI-414 electrodes have not been extensively used in industry or in other research projects; thus, factors affecting the electrode's performance have not been fully identified. The electrodes must be recalibrated after sterilization because it has been observed that calibration characteristics change during the ethylene oxide process.

The temperature of the buffers used during calibration and that of the medium being measured must be considered. Calibration will be performed at 25°C to simplify the calibration process. The temperature of the wound surface varies from 33°C to 41°C. During the testing of the electrodes, it was discovered that the electrode characteristics that were determined by calibrating at room temperature and those found by calibrating at 37°C, the theoretical temperature of the wound, do not vary greatly. In addition, the two characteristic lines obtained from calibrating at 25°C and 37°C intersect in the region of 6 to 8 pH units. This is ideal for this application because tissue pH values should fall between 6.5 and 7.7 pH units. In addition, the electrode is placed on the tissue for approximately one minute, making the effects of any temperature variations even less significant. Thus, calibrating at room temperature and subsequently taking tissue pH measurements will not cause significant errors. See sections 7.1 and 8.1 for a full analysis of this subject.

The following procedure has been developed by researching methods by which other investigators have calibrated glass microelectrodes and by using trial and error in calibrating the MI-414 electrodes.

1. Place the electrode in a buffer solution with a pH of 4 pH units. Let the electrode soak in this buffer for at least 12 hours.
2. Setup the hardware/software system for calibration.
3. Immerse the electrode in a pH of 7 units for approximately 5 seconds and then in a pH of 4 units for another 5 seconds. Repeat this one more time.
4. Place the electrode in the more acidic of the two buffers that have been chosen for calibration, here the buffer has a pH of 6. Allow the electrode reading to stabilize.
5. Place the electrode in the second buffer (the more basic of the two, here a pH of 8). Allow the electrode reading to stabilize.
6. Rinse the electrode and place it back in the storage buffer (4 pH units).

These steps are done in conjunction with the running of the software program. When the two-point calibration option is chosen from the main menu, the program will lead the user through the calibration process. The user must enter the values of the pH buffers that are being used and indicate whether the electrodes have stabilized. The program will record the voltages that are read while the electrode is in each of the buffers and use these voltages to calculate the slope and intercept of the calibration line.

Once the calibration has been performed, the voltage levels that are attained for each of the buffers are used to calculate the electrodes' calibration characteristics. It is traditional to express these characteristics in the equation of a straight line ( $y = mx + b$ ). The output,  $y$ , is the electrode potential in millivolts and the input,  $x$ , is the pH of the medium in which the electrode is immersed. The two parameters that must be determined are the slope and the intercept. The slope and intercept are calculated by the following equations:

$$\text{slope} = (mV_1 - mV_2)/(pH_1 - pH_2) \quad (7.1)$$

$$\text{intercept} = mV_1 + (\text{slope})(pH_1) \quad (7.2)$$

The slope is in units of mV/pH and the intercept is in mV. Thus, the lines describing the electrodes' calibration characteristics have negative slopes and will be plotted on graphs of millivolts versus pH. For any pH value, the corresponding voltage that the electrode will produce can be discovered by using the calculated slope and intercept and the equation of a line.

$$E(\text{mV}) = (\text{slope})(\text{pH}) + \text{intercept} \quad (7.3)$$

This equation is the basis for determining pH values of the medium in question. Solving the equation for pH gives the following:

$$\text{pH} = (E(\text{mV}) - \text{intercept})/\text{slope} \quad (7.4)$$

To attain a basis for later calibrations, each of the electrodes was calibrated and the calibration curves were plotted using Excel. These graphs can be referred back to later on in the research to see if and how the electrode characteristics have changed over



time due to environmental factors that the electrodes encounter during the research. The voltage that each electrode produces for a specified pH value should be within a given range and can therefore be used as an indicator of the pH electrode's correct operation. Since little is known about the MI-414 electrodes, checking the calibration characteristics by referring back to the calibration curves determined at the beginning of the research is a good laboratory practice. It will also eliminate the occurrence of performing tests with a faulty electrode, which would produce erroneous data and necessitate retesting.

### 6.3 Animal Studies

Animal studies will be conducted at UMASS Memorial Healthcare in Worcester, MA. The studies will be a joint effort between WPI and UMASS. Adam Lowenstein, M.D., who is a surgical resident at UMASS, prepared the animal protocol that will be used for the studies and is the principal investigator of the study. This section will summarize the information contained in the protocol, including the methods that will be used during the animal testing.

The title of the animal studies, *Correlation between pH and Quantitative Bacteriology*, explains what is sought to be accomplished during the testing. pH measurements and biopsies for bacteria quantification will be taken from wounds that are created in Sprague-Dawley rats. The exposed tissue will be infected with bacteria to create the model for a contaminated wound. The bacteria in the created wound will be allowed to grow for a set period of time, producing varying levels of infection. The levels of bacteria and pH will then be measured and compared, and the relationship between the pH and bacteria will be analyzed.

The animals used during this study will be Sprague-Dawley male rats, weighing approximately 250 grams. The justification for using animals in this research is twofold. First, there is no known non-animal model that can accurately predict the tissue's inflammatory response to wound infection and allow for the measurement of tissue pH. Secondly, an established correlation between wound pH and bacteria levels has applicability in wound healing in humans, and animal studies are a necessary precursor to clinical testing. The use of rats is appropriate for this animal study because rats exhibit the necessary inflammatory response to inoculation. Animal studies will afford information that will be valuable in future clinical trials.

#### 6.3.1 Animal Studies Protocol

Several attempts were made to achieve a successful animal model. The model of wound infection that was originally proposed for this study is described in a protocol that was previously approved by the UMASS Memorial Healthcare Department of Animal Medicine. This animal protocol is modeled after a study described by Saymen, et al. [41]. This section will describe the models that were used and the methodology for performing the animal studies.

Regardless of the model that is used, the rats are prepared for the procedure in the same way. A rat is first removed from its cage and placed in a container with Halofane. This makes the rat drowsy and easier to handle. The rat is anesthetized using 5 mg/kg of Rompun and 20 mg/kg of Ketamset. These anesthetics are administered intramuscularly.

Once the rat is anesthetized, its hair is shaved off of the dorsolateral surface, and the shaved area sterilized. A wound is then created in the shaved area by using a surgical blade to incise a one-inch square of skin overlying the panniculus muscle. At this point in the procedure, two different models were tested to devise the procedure that will produce the best experimental results.

#### 6.3.1.1 Model One

Saymen et al. developed a model to create infected wounds in rats [41]. They proposed that a total of forty-two rats, broken into groups, be used in the study. Table 1 displays the number of rats in each group and the length of time that the bacteria should be allowed to grow in the induced wounds. Each of the study groups contains ten rats with infected wounds and three rats that will be used as controls. A preliminary study will be done with three controls to practice the surgical and measurement procedures. Each group of rats will be housed in separate cages for identification purposes.

*Table 6.1: Categories of rats and times of biopsies following inoculation*

Number of Rats	Time of Biopsy following inoculation
3 (controls)	0
10 + 3 (controls)	24
10 + 3 (controls)	36
10 + 3 (controls)	48

Once the skin is incised, the full thickness of the skin in the one-inch square area will be removed and discarded. A tissue pH measurement will be taken of the healthy exposed tissue and will be used as a reference. The next step is to inoculate the underlying tissue with  $10^7$  Pseudomonas sp. bacteria. This is done by pipeting 0.1 ml of the cultured bacteria onto the panniculus carnosus. This action essentially pours the bacteria over the exposed tissue.

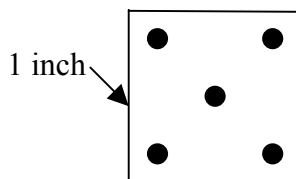
#### 6.3.1.2 Model Two

The second model is very similar to the first with the exception of the way in which the bacteria is applied to the exposed tissue. In this model, the bacteria is injected into the tissue. This speeds up the progression of the infection in the wound. Another change that was made is the way in which the groups were divided. Controls were not used in this study because it was decided that they were not applicable for this study. In addition, the 36-hour study was removed. The differences in the level of bacteria that grows between the 24 and 36 hours study or the 36 and 48 hour study was not significant. Thus, ten rats were used in each of the 24 hour and 48 hour studies. This model was more applicable to our research than the one proposed by Saymen et al.

After the wounds are infected with bacteria, they will be covered with an Op-Site occlusive dressing. The wound will then be covered to ensure that the rat's movements do not effect the exposed tissue area. In addition, the covering of the wound creates a

humid environment in which the bacteria will thrive. The methods for covering the exposed tissue are discussed in the next section.

At the time of biopsy, five pH measurements will be taken, at sites on the wound as seen in Figure 6.1. See chapter 5 for an explanation of how the pH measurements are acquired. The biopsies will be taken at the location at which the pH measurement is taken.



**Figure 6.1: Representation of the wound area and the locations of the pH measurements and tissue biopsies**

Once the rat recovers from the anesthetization, it will be left its cage for a set amount of time. Varying the amount of time after the wound is inoculated will cause different degrees of wound infection. Varying amounts of bacteria should cause different levels in the tissue pH. The discovery of this fact is the main focus of the research.

The animals will be sacrificed in accordance with standard UMASS Memorial Healthcare protocol. The pH measurements will be saved on the hard drive of the laptop computer used for pH measurements, for later analysis. The tissue biopsies will be sent to the lab for quantitative analysis of bacteria. This process involves a standard plate count method in which colonies are counted after 48 hours of incubation at 35°C. The bacterial count is measured as the number of cells per unit surface area of the tissue biopsied. The bacterial concentration is equal to the total viable count of the tissue biopsied divided by its wet weight.

### **6.3.2 Methods for Securing the Wound**

Once the rat's skin is removed and the bacteria is applied to the tissue, the wound must be covered. As explained, this will ensure that an appropriate environment is created for the growth of the bacteria in the tissue. The proper criteria for the wound "cover" are as follows:

1. cover the wound completely to allow for a humid environment to develop on the tissue surface;
2. provide enough comfort and strength to dissuade the rat from disrupting it; and,
3. make no disturbance to the rat's physiological and behavioral states.

All three of these criteria must be met before the chosen covering method will be accepted. The method of covering the rat's wound will affect the outcome of the experiments as well as the livelihood of the rat. Therefore, this is an extremely important issue in the development of an efficient animal model in our research.

Unfortunately, once a methodology for covering the exposed tissue is developed, the only way to test whether it is acceptable is by performing the experiment. Thus,

several tests were done to determine the methodology that would best fulfill the objectives of the animal study. Each test was done as explained in the procedures so that if a methodology worked well, the data could be used and the sacrificing of the rat would not be a wasted effort.

Several methods were tested, many of which failed. The types of coverings that were used will be detailed here. See the corresponding section on discussions for reasoning why a specific method failed or succeeded. Data was taken from testing that worked properly, even though new and better techniques were being constantly explored. Following are the different techniques that were used to secure the wound site:

1. The first attempt was to place a plastic cap on the wound and secure it with bandages by wrapping them around the rat's body.
2. The next method was to place a standard bandage over the exposed tissue and place Benzoin on it to dissuade the rat's from chewing at the bandage.
3. The third method is an alteration of the second. In addition to the bandage and Benzoin, a wire grating was stapled on top to prevent the rat from chewing at the bandage.
4. The fourth technique is an actual change to the procedure explained above. Instead of completely removing the rat's skin, it is partially excised and pulled back so that inoculation of the tissue can be performed. The skin flap is then secured onto the rat by staples.

The fourth method used appears in a research paper that explains a rat wound model for human chronic wounds [42]. All of these methods were developed in an attempt to fulfill the criteria needed to develop a good animal model for this research. None of the articles that were reviewed during the preparation of the animal model detail the possible difficulties that may be encountered during animal studies of this kind. Thus, this was a learning experience which slowed the progression of the animal studies.

Each of the methods that was used was an attempt to develop the best infected wound model. The aim is to grow bacteria in the rat's tissue and to take tissue pH measurements of the infected areas. Although complications arose in each of the models, data was acquired during each study.

### **6.3.3 Final Animal Model**

This concludes the explanation of the procedures that will be used for the animal studies. Both of the two explained models in conjunction with the methods for securing the wound were tested. The combination of animal and securing method that proved to be most efficient and accurate was model two and the fourth method for securing the wound. This model will be used to attain the final results. See the corresponding section in the chapter on discussions for analysis of the models and an explanation of why one of the models worked most efficiently.

The two most vital pieces of information collected from the rats are the tissue pH levels and the corresponding bacteria counts. It is important to perform animal studies to obtain preliminary results and justify the appropriateness of clinical studies. Thus, it is crucial to carefully prepare the animal model and continually improve it to achieve the most accurate results.

#### 6.4 Sterilization Protocol

It is of extreme importance to have a good sterilization protocol for the clinical testing portion of this research. The patients will be seen at the UMMC outpatient clinic; thus, every material that will be in contact with the patient must be sterile. An object is considered sterile if it has been sterilized by the manufacturer and individually packaged, or is gas sterilized before use.

The pH electrodes are not sterilized by the manufacturer and are not disposable. Therefore, they must be sterilized and kept sterile until the time of contact with the patient. Sterilization is performed at the UMMC Sterile Area. At this location, the electrodes are gas sterilized overnight in ethylene oxide. This form of sterilization is appropriate because it kills all bacteria on the electrode surface without damaging the electrode. Methods such as autoclaving will harm the electrodes because of the extreme temperatures that are used.

The sterilization of the MI-414 electrodes was reviewed during the testing of the electrodes (see section 6.1.4). This was beneficial in developing the sterilization protocol. To prepare for sterilization, the electrode is placed in the foam casing that it was originally packaged in. The glass sleeve that protects the electrode tip during storage is not used and the foam area surrounding the tip is removed. This is done so that the electrode tip (the portion that will be in contact with the patient) is sterilized properly and no material adhere to the tip during the process.

It was found that the electrolyte that is held in the electrode casing leaks out during the sterilization process because of a change in pressure differences between the electrode's inner tube and the environment. The excess electrolyte then forms a crusty coating on the outer tip of the electrode. This is unacceptable because the aim of sterilization is to attain an electrode that can be considered antiseptic. To solve this problem, the electrolyte will be removed from the electrode casing prior to sterilization. Distilled water will be used to rinse out excess electrolyte. After sterilization, the electrolyte will be replaced.

The next issue is the calibration of the electrodes. It has already been determined, from testing of the electrodes, that the gas sterilization process changes the electrode's calibration characteristics. Because it is imperative that the measurements are accurate during testing, a two-point calibration will be performed after sterilization. Before calibration can be performed (and after sterilization), the electrodes must be conditioned. This is done using Lactated Ringer's solution, which is a sterile saline that has a slightly acidic pH. A sterile, disposable syringe and needle are used to extract three mL of Lactated Ringer's from an IV bag. The solution is then deposited into a sterile, disposable test tube. Tegaderm HP, which is a sterile transparent dressing material, is secured over the top of the test tube. The sterile electrode is then placed in the Lactated Ringer's solution by punching a hole through the Tegaderm. This material works well because it is sterile and also holds the electrodes in place in the Lactated Ringer's solution.

Once the electrodes have soaked in the Lactated Ringer's solution for approximately twelve hours, they are ready to be calibrated. The pH buffers used for the

two-point calibration must also be sterile because they will come in contact with the electrodes before testing. It is sufficient to sterilize the pH buffers by filtering them through a filtration material that has pores that are smaller than any contaminants that may be present. Sterile Acrodiscs are appropriate for the filtering of the pH buffers. These discs are sterilized by gamma irradiation by the manufacturer and are individually packaged and disposable. The disc is attached to the end of a syringe. Three mL of pH buffer is poured into a syringe and pushed through the filter into a sterile, disposable test tube. The Tegaderm HP is placed over the test tube. The same is done for the second buffer. The calibration process is then performed (see section 6.2). Once the electrodes are calibrated, they are placed back in the sterile Lactated Ringer's solution until testing is performed.

Thus, the sterilization protocol allows for the electrodes to be sterilized, calibrated, and prepared for testing while keeping the electrodes sterile. The procedures are summarized in the following steps. Each electrode will be put through this procedure before being used on a patient.

1. Remove the electrolyte from the electrode. This is done to eliminate the leaking of the electrolyte that occurs during sterilization because of pressure differences.
2. Flush the electrode with distilled water to rinse away any remaining electrolyte that would cause crusting on the electrode's surface.
3. Sterilize the electrode by ethylene oxide (UMASS Memorial Central Sterile Area).
4. Refill the electrode with new electrolyte.
5. Filter-sterilize the two pH buffers, used for calibration, into a sterile test tubes.
6. Calibrate the sterile electrode with the filtered buffers, using a sterile saline to rinse between buffers.
7. Place sterile Lactated Ringer's in a sterile test tube and secure the electrode in this test tube. Leave the electrode in this solution until the time of testing. This serves the purposes of keeping the electrode sterile and conditioning the electrode in an acidic solution.

These steps summarize the sterilization protocol that will be used for the clinical testing portion of this research. Great care must be taken in handling the electrodes and ensuring that they remain sterile after being exposed to the ethylene oxide process. Keeping the electrodes sterile prior to contact with patients is required by FDA and hospital regulations and is an ethical issue that must be reviewed thoroughly. Following the developed sterilization protocol will allow this study to comply with all safety regulations.

## 6.5 Clinical Studies

Once animal testing was performed, it was apparent that the instrument and electrodes were working, and the research's main hypothesis seemed to be true, we could proceed with clinical testing. Only at this stage will all aspects of the study be able to be tested. Although animal testing is helpful as a preliminary step, the environment encountered in the hospital and the wounds seen in the patients cannot be accurately simulated. Also, patients have a variety of chronic wounds, the examination of which will produce realistic results.

Careful preparation was taken in choosing the materials that will be used during clinical testing. This is important so that the protocol is in accordance with hospital and Food and Drug Administration regulations. The sterilization procedures, explained in the previous section, are carried out before clinical testing is performed. Once the electrodes have been sterilized and calibrated, the monitoring system is ready for use.

After Dr. Dunn, the principal investigator of the study, has talked to the patient about the procedure, he/she must agree to participate and sign a consent form. This consent form, which can be seen in Appendix A, is mandated by the hospital and the FDA. The consent form explains the procedure that will be performed during the visit with the patient and the rights that the patient is entitled to. The patient must understand the following: 1) participation in the study is voluntary; 2) withdrawal from the study is allowed at anytime; and, 3) information about changes in the study will be readily available to the patient. The consent form also details any risks and/or benefits that may exist during the patient's participation in the study. There are no direct benefits in this study yet, development of new medical practices that stem from this research would benefit patients in the future. The patient will not incur any costs and his/her identity will be kept confidential.

Finally, the patient is requested to sign the consent form to confirm that he/she has read the form, understands what is involved in the participation in the study, and has discussed issues with the principal investigator, Dr. Dunn. Once the patient has signed the consent form, testing may begin. The testing will be performed at UMASS Memorial Healthcare's outpatient clinic during the patient's regular visit. The following materials will be brought into the patient room for testing:

- pH monitoring system
- patient information sheet
- pH electrodes
- Lactated Ringer's
- sterile test tubes
- digital camera
- wound measuring guide

In addition, materials necessary for normal treatment of the patient will be used. The procedure will begin by taking information about the patient including age, gender, and race (optional). Next, information will be recorded about the wound, including age from initiation, appearance, type, cause, and treatment on the patient information sheet (see Appendix B). Then, one of the sterile pH electrodes will be selected and attached to the unit. The corresponding calibration characteristics will be entered into the system. The monitoring system is now prepared for testing.

The next step is to place one of the sterile wound measurement guides (see Appendix C) on the patient's wound. A marker will be used to identify on the guide the locations in the wound that will be examined. A digital photograph will be taken of the wound measurement guide on the wound to achieve a sense of the wound size. The wound measurement guide will then be removed and a digital photograph will be taken of the exposed wound without the measurement guide to get a better look at the wound's appearance.

The pH electrode will then be placed on the wound tissue. The electrode should be held in place for up to forty-five seconds to attain an accurate reading. If the electrode stabilizes, before that time, the software program will recognize this and end the measurement of that point. All pH values registered by the system are written to a text file, and the program will calculate an appropriate average for each measurement point. The electrode will be rinsed in sterile Lactated Ringer's solution between each measurement point. Measuring of each point on the wound will proceed in the same way.

After each identified point on the wound is measured, a tissue biopsy will be taken at the same location. These biopsies will be cultured, and the bacteria counts in the tissue will be determined. Once interaction with the patient has concluded, the wound measurement guide and Lactated Ringer's used for rinsing will be discarded. The electrode will be replaced to its storage test tube. The measurement locations, tissue pH, and biopsies will be carefully recorded so that they can be related to each other during analysis of the data.

Five electrodes are used for the clinical testing portion of this research. After the electrodes are used to measure tissue pH, they are put through the gas sterilization process and are calibrated prior to the next set of tests. See sections 6.2 and 6.4 for explanation of these procedures. The accurateness of the results relies on the careful handling and preparation of the electrodes. The issue of sterility is equally important. Steps were taken to ensure that all of these issues were addressed meticulously.

## **6.6 Data Analysis**

Three different stages of analysis of the acquired pH data must be performed. The first involves the determination of a single pH value from the data points that are acquired from one measurement position. It is necessary to take measurements of the tissue pH at one position for approximately a minute to get a good estimation of the tissue pH level at that point. The second stage consists of analyzing the variation of tissue pH levels within one subject and between different test subjects. The third stage involves the analysis of the tissue pH levels in relation to different descriptors of the wound's condition. These parameters include bacterial contamination, location, and wound appearance. All three stages of the analysis are essential to the understanding of the pH signals and the achievement of the research objectives. The first helps to determine the true pH level of the tissue; the second analyzes pH variations; and the third aims at achieving the goal of this research, which is to determine a relationship between pH levels and chronic wound properties.

### **6.6.1 Analysis of pH Signals**

Due to the adjustment of the electrode to the medium with which it is in contact, the pH signal can exhibit large variations initially. Also, variations are introduced because of subject movement (breathing in the rats and actual movement in humans). Therefore, signal processing techniques must be developed to attain an appropriate average of the pH signal which will be representative of the actual tissue pH level at that point.



The algorithm that is used, termed the pH stabilization algorithm, is detailed in section 5.4.2, within the chapter on software description. The main idea is that the electrode is stable if the pH signal has not varied greatly from the mean of the last twenty samples. The signal is analyzed as it is being acquired. The software program determines the stability and then stops the pH acquisition if the signal has stabilized. The program also informs the user if the signal has not stabilized in a set amount of time. In this case, an average of the most recent sample points that are within the mean absolute deviation from the calculated mean will be used as the pH level for that point.

This algorithm works efficiently for the animal studies. It is altered slightly for the clinical studies to reduce the amount of time needed for each tissue pH measurement. When the acquired data is taken offline for analysis, the signals and the pH level that was calculated for that specific measurement are reviewed. This is done to ascertain that the algorithm calculated an appropriate average as well as to view trends in the pH signals. Common patterns in the pH signals from different rats or patients will afford information about the electrode operation in a testing environment and give us valuable information about its applicability in future research.

### **6.6.2 Analysis of Tissue pH Variations**

Once the signals have been acquired and an average is calculated for each measurement location, the data points must be analyzed collectively. Similar techniques will be used for analysis of the data obtained from the animal and clinical studies. The amount of information acquired varies with each test, but the principles are the same. The overall goal is to determine the relationship between pH levels and other properties of the wound, specifically bacteria content, appearance, and location.

The first step will be to put the pH data points in a scatter plot to understand the variation that is present in the pH values taken from different rats or patients. This will give us a picture of the typical pH levels found in the created wounds in the rats and in the chronic wounds found in the patients. Another plot that will be used is the stratified plot. This plot groups the measurement points for each subject in a different position on the x-axis; therefore, the x-axis displays the subject number and the y-axis displays the pH values. This graph will help to determine the within variation (differences in pH levels for one subject) and between variation (differences in pH levels between different subjects).

The variations that are apparent between the pH measurements of different subjects may be partly due to the fact that the “normal” pH level of a given person or animal is different from that of another. This is resolved in the animal testing by taking a measurement of the normal tissue pH and calculating differential measurements (percentage of the actual pH value from the normal value). This normalizes the data so that the measurements taken from all of the rats can be compared collectively. Taking a healthy tissue pH measurement from the clinical patients is not possible. This would cause additional pain to the patient and is not part of the clinical protocol.

Another plot that will be used to take a different look at the pH data is a frequency histogram. This graph will display the regions in which most of the pH values fall and identify any outliers in the data set. A final technique that will be used to view the tissue pH variations will be the formation of pH image. This “image” will be a two-

dimensional contour plot that graphically shows the variations of tissue pH area from which it was acquired. The software program, Mathcad, will be utilized for its interpolation algorithms and graphical display. This tool will aid in visualizing the variation of pH levels in relation to the origin of the measurement point. Together, the scatter plot, stratified plot, and frequency histograms, and pH image will give us a good picture of the variation of pH within one subject and among the chosen sample.

### **6.6.3 Analysis of the Relationship between Tissue pH levels and Wound Properties**

The next step will be to determine the relationship between the pH levels and other wound properties. One of the most interesting aspects of the chronic wound, and the hardest to determine, is the bacterial contamination level. Infection is a leading cause in the nonhealing state of a chronic wound. Thus, we would like to determine if tissue pH levels directly relate to bacteria content in the tissue. To do this, we will compare the tissue pH levels to the bacteria counts found in the tissue. During the animal studies, tissue biopsies are taken for every pH measurement and quantitative bacteria counts are determined. Conversely, during the clinical studies, only a qualitative swab culture can be taken from the patient at a representative point on the wound. This makes it difficult to perform a strong statistical analysis of the bacteria and tissue pH data from the clinical testing portion of this research.

For the data acquired during animal studies, the bacteria levels will be graphed versus the pH levels. This scatter plot should be analyzed to see if any type of association, linear or nonlinear, is noticeable. Another plot that will be beneficial to look at is a median trace. This is formed by dividing the x-axis data, here pH levels, into slices. Then, the median in each slice for the x and y-axis data, here the bacteria counts, is found and plotted for that interval. This essentially smoothes the data to see if there are any underlying trends that can be noticed.

If the association between the bacteria content and the tissue pH levels is linear, then several other statistical techniques can be used to analyze the data. The Pearson correlation coefficient, which is a measure of the strength of the linear association between two quantitative variables, can be calculated. In addition, linear regression can be used to determine a model for the data. This methodology treats one variable as the predictor or independent variable and the other as the response or dependent variable. In this study, the tissue pH level would be the predictor and the bacteria content would be the response. These methods depend heavily on a linear association of the data.

It is also of interest to relate the data to the location in and appearance of the wound. This will be done qualitatively by recording the positions on the wound where the measurements were taken from and by taking digital photographs of the wounded area. By viewing the photographs, it can be seen what areas of the tissue appear reddish and healthy and what areas have low blood supply and are infected and therefore appear unhealthy. Another important element is the doctor's opinion of the wound's status. Dr. Dunn, the principle investigator of the clinical studies in this research, has experience with the patients being tested and can comment on whether the wounds in a given patient are on their way to recovery or are chronic problem wounds. This is another classification of the wounds that can be related to the acquired tissue pH levels.

Although much of the data is being qualitatively analyzed, the information afforded by this analysis will be beneficial to the study of chronic problem wounds. The instantaneous acquisition of tissue pH levels in chronic wounds is of great interest in the clinical field. Thus, data that can exemplify variations of tissue pH within the wound will provide a good scientific contribution. Correlation levels between bacteria content and tissue pH is difficult to test in the clinical environment but will be looked at to determine what kind of relationship exists. Tissue pH is an excellent tool for characterizing tissue properties, and this research will hopefully further the knowledge in this field.

## 7. RESULTS

In this chapter, all of the results that were attained during the testing portion of this research are presented. The results are displayed in graphical as well as tabular form so that they could be well understood. Three major areas are concentrated on in this chapter: results of electrode testing, results of animal studies, and results of clinical testing. The results from the electrode testing were needed only to acquire a better knowledge of the operation of the electrodes and the pH monitoring system. These results helped to avoid technical problems that might have arisen during animal model and clinical testing. Because the electrode testing is not the focus of the research, all electrode tests were not necessarily performed to produce statistically significant results. The data from the animal model and clinical testing will be presented in their entirety.

### 7.1 Testing of the MI-414 Electrodes

The electrodes were thoroughly tested using the protocols described in the chapter on methods. The results that were achieved are important to the understanding of the operation of the electrodes. The acquisition of pH measurements is a critical part of this research; thus, accurate and efficient use of the electrodes is extremely important.

#### 7.1.1 Results of Time Constant Determination

The following are the results from testing the stabilization time of the electrodes. Two areas in which this characteristic is used are in calibration of the electrodes and in pH acquisition. It is desirable for the electrode to react as quickly as possible to changes in the medium with which it is in contact.

##### 7.1.1.1 Calibration Time Constant

Figures 7.1 displays examples of the signals measured during calibration. This signal is a result of the electrochemical reaction that occurs between the electrode and the buffer solution. It gets digitized and is then registered by the software program in machine units. These units are then converted to the actual voltage levels (see Chapter five for a more thorough explanation).

The calibration was performed until it visibly appeared that the electrode had fully stabilized. Two different electrodes were tested in several trials. The graphs show that the two electrodes produce slightly different voltage levels. Table 7.1 displays the time that it took for each electrode to stabilize during each trial. An average and standard deviation are calculated.

##### 7.1.1.2 Electrode Response Time

The response time of the electrode to step changes in pH is a valuable characteristic. Figure 7.2 shows the change in pH acquired during step tests. The electrode was switched between two different pH buffers, and the response was measured. The quicker this transition occurs, the more useful the electrode will be. It can be seen that the electrode is allowed to stabilize before and after the change occurs.

*Table 7.1: Table of times needed for stabilization during calibration. The data is plotted in Figure 7.1*

Buffer Acidity (pH)	Final Machine Unit Level	Time for Stabilization (minutes)
6.0	316	6.99
6.0	316	7.68
6.0	312	8.10
6.0	310	7.15
8.0	300	6.43
8.0	298	5.85
8.0	294	7.10
	<b>Average</b>	7.04
	<b>Standard Deviation</b>	0.746

The point of interest in these graphs is the time that it takes for the electrode to register a change in the pH with which it is in contact. The change in pH has two apparent components: a steep almost linear change followed by a gradual asymptotic stabilization. Because the signals do not exhibit a purely exponential trend, it does not make sense to talk about the time constant of the electrode response. Therefore, several different parameters were identified. Table 7.2 shows the data from six trials and the averages that were calculated for the specified parameters. These parameters are labeled in Figure 7.2. Table 7.3 shows a summary of the statistics calculated from these response time tests. It can be seen that it takes approximately thirty-five seconds for full stabilization.

*Table 7.2: Data describing the response of the electrode to step changes in pH. This data is obtained from the signals seen in Figure 7.2 and is summarized in Table 7.3*

Measured Parameters	8 to 6	8 to 7	7 to 8	6 to 8	7 to 6	6 to 7	Averages
Initial Time (seconds)	24	14	22	25	44	25	
Time 1 (seconds)	29	18	24	30	49	29	
Time 2 (seconds)	62	56	48	61	78	53	
pH 1 (pH units)	8.07	8.03	7.00	6.08	7.04	6.04	
pH 2 (pH units)	6.34	7.16	7.80	7.80	6.19	6.87	
pH 3 (pH units)	6.08	7.05	8.04	8.04	6.04	7.01	
Delta Time 1 (seconds)	5	4	2	5	5	4	4
Delta Time 2 (seconds)	33	38	24	31	29	24	30
% of final value at Time 1	95.69%	98.51%	97.10%	97.10%	97.50%	98.00%	97.32%
Slope (pH/s)	-0.348	-0.217	0.407	0.347	-0.168	0.211	

*Table 7.3: Summary of statistics of response time of electrode to changes in pH calculated for data in Table 7.2.*

<b>Time of initial drop of pH</b>	5 seconds
<b>Time of gradual stabilization</b>	30 seconds
<b>Percentage of final pH reached after the initial drop</b>	97%
<b>Average Initial Slope (fall in pH)</b>	-0.19 pH/s
<b>Average Initial Slope (rise in pH)</b>	0.26 pH/s

## 7.1.2 Results of Stability Tests

### 7.1.2.1 Long Term Stability

The long-term stability of the electrodes can be evaluated by using the system to record the pH of a given buffer for an extended period of time. The variations in the recorded pH during a typical long-term test that was performed for approximately 12.5 hours can be seen in Figure 7.3. Additional long-term tests were performed and confirmed that the results seen in Figure 7.3 are reproducible.

Because the electrode is calibrated before each testing period, we are concerned with the chance of drift causing error during that testing time. This can be calculated by finding an approximate slope of the signal displayed in Figure 7.3. During the long-term tests, the electrodes would typically drift 0.088 pH unit/12.5 hours. The drift is always linear. Thus, the approximate drift is 0.00012 pH units per minute. In this research, the electrode is used between 15 minutes and an hour before being recalibrated. Fifteen minutes of testing may result in about 0.0015 pH units of drift. One hour of testing could result in 0.007 pH units of drift. These values are not significant for this research and therefore will not result in erroneous data interpretation.

### 7.1.2.2 Stability while Holding the Electrode

During testing, the electrode will be held by hand. Testing was done to determine if this would greatly affect the results. Figures 7.4 shows the results of holding the electrode with the right and left hand to a sponge that is saturated with 7.0 buffer. The recorded pH level is in the 6.5 range (not at 7.0) because the contact the electrode has with the pH buffer in the sponge is not direct. The sponge material and the environment play a role in affecting the pH measurement. It can be seen that the variation in measured pH is about 0.01 pH units, which is not significant enough to necessitate further exploration. Several tests were done with various electrodes. The variation between tests was not noticeable but the pressure that was applied during the test did effect the results. This experimental setup was devised in an attempt to simulate the touching of the pH electrode to wound tissue.

Another test was done to see to what pH value the electrode would stabilize when exposed to the air. This is applicable because the electrode often comes into contact with air when it is being transferred between different environments. The electrode stabilized to about 7.6 pH units. This may vary slightly, but it gives us an idea of the typical value that can be expected.

### 7.1.3 Results of Temperature Dependence Tests

Several tests were done to determine if and how the temperature of a medium affects the measured pH. Varying temperatures are encountered in the wound, although this has never been explored to our knowledge. The wound tissue will typically be at temperatures between 33 to 41°C. It has been documented that the pH of buffers varies with changes in temperature; thus, the electrode's response to these changes is of interest. Figures 7.5 through 7.7 show that when starting from approximately 32 °C, the recorded pH first decreases and subsequently increases. This response is in accordance with the theoretical change in pH with changes in temperature. As explained in the background section, the pH is proportional to the temperature of the medium (see Equation 4.4). Therefore, as the temperature rises, the pH will rise; conversely, as the temperature drops, the pH will drop. This relationship can be seen in the results for testing the temperature dependence of the electrodes. The average rate of change in the recorded pH when the temperature is varied between 36.5 and 44 °C is 0.0055 pH/ °C. When the temperature is varied between 33 and 36 °C, the average rate of change of pH is -0.01 pH/ °C.

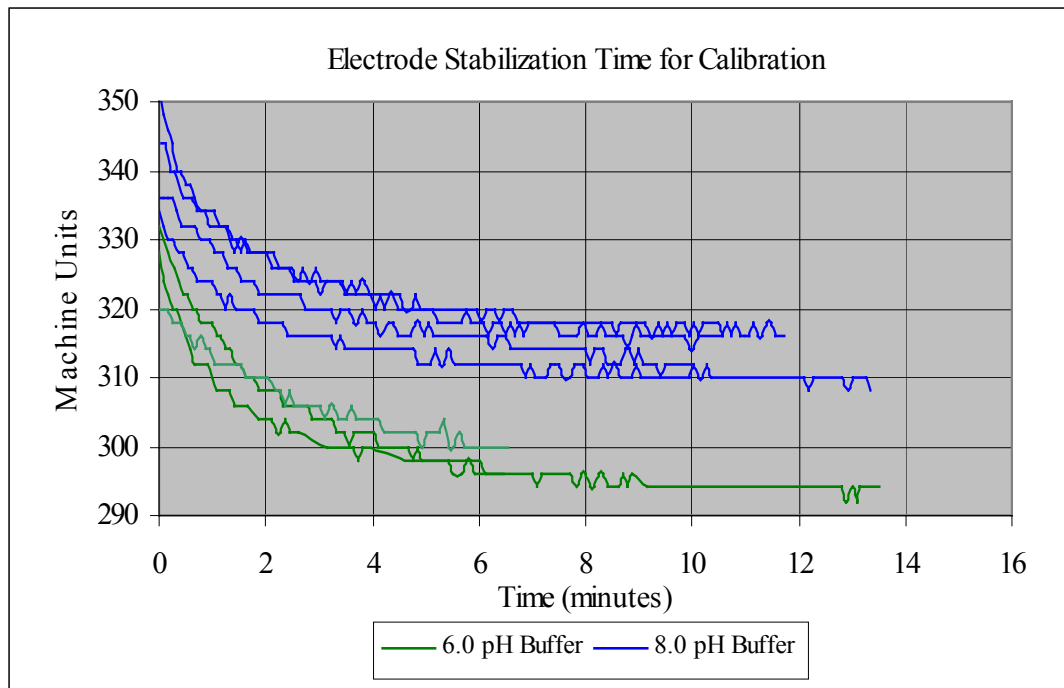
### 7.1.4 Effects of Sterilization of the Electrodes

Successive sterilizations were performed on several of the electrodes. Any sign of change in the electrode operation was monitored and changes in the calibration characteristics were recorded. One general observation was that residue formed on the outside of the tip of the electrodes after they were sterilized. In addition, the level of electrolyte decreased in the electrode casing. Thus, it appears that the residue at the tip is a result of the leakage of the electrolyte during the sterilization process. No other physical alterations were noticed as a result of the ethylene oxide process.

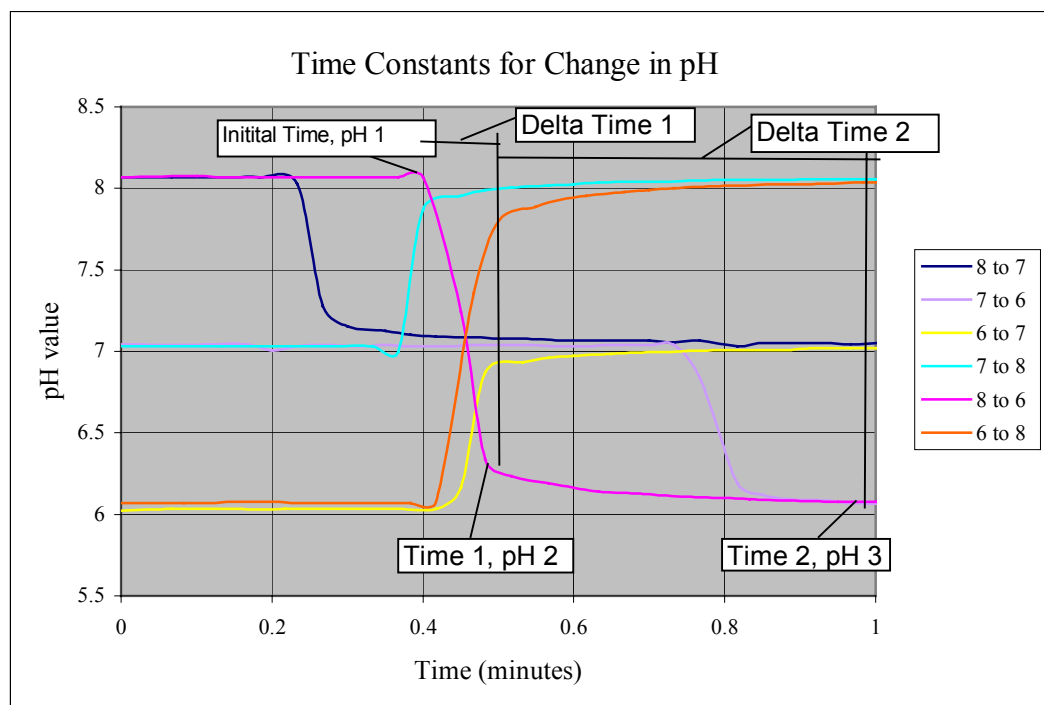
The electrode's characteristics did change as a result of the sterilizations. Table 7.4 shows the change in the electrode characteristics for one of the electrodes that was sterilized three times. Similar changes in slope and intercept were seen for the other electrodes that were sterilized.

Table 7.4: Electrode 64236 calibration characteristics before and after sterilization.

Sterilization Number	Slope (mV/pH)	Intercept (pH)
0	-62.567561	6.977164
1	-62.908839	7.225136
2	-62.965718	7.158934
3	-62.624441	7.197257

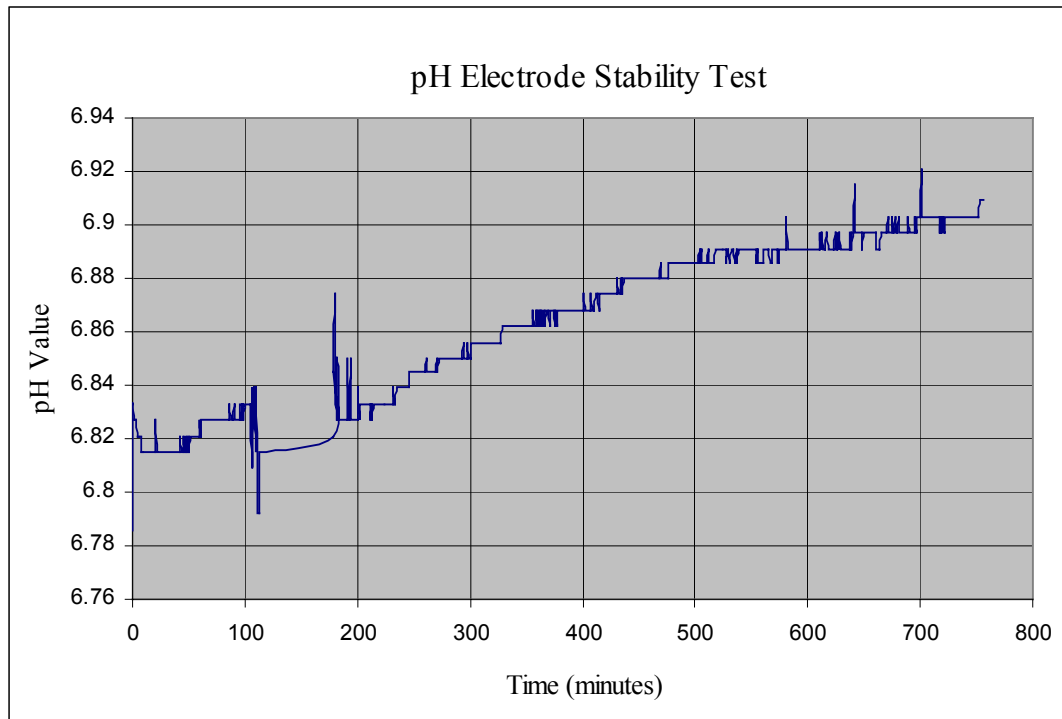


**Figure 7.1: Typical electrode stabilization recordings during calibration in 6.0 pH and 8.0 pH buffers.**

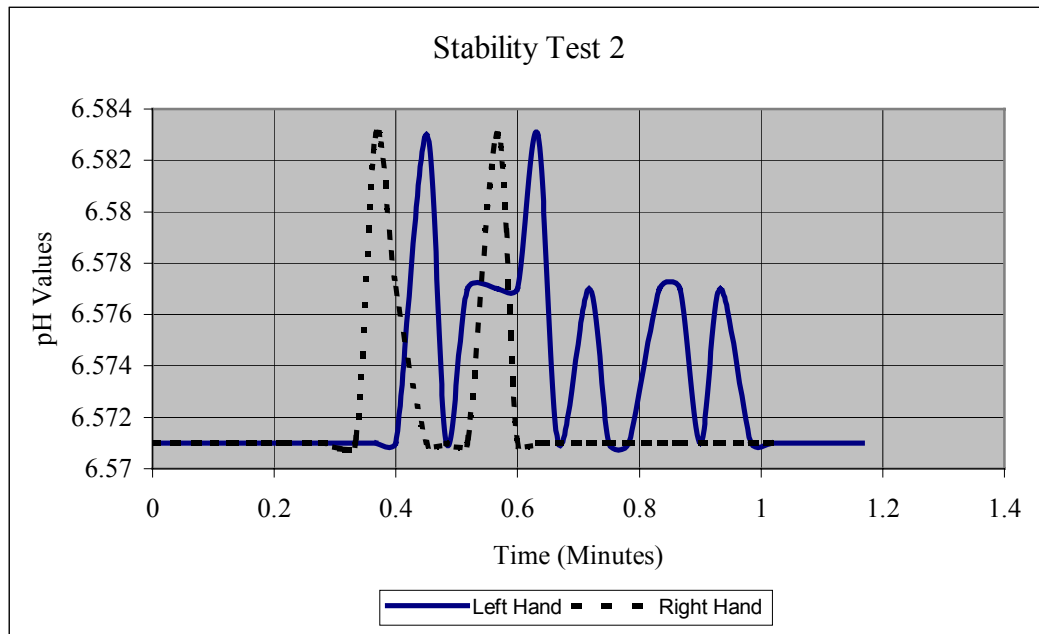


**Figure 7.2: Measured responses of the pH electrodes when immersed in an initial pH buffer and then switched to a second pH buffer. The times and levels of interest are labeled and are analyzed in Tables 7.2 and 7.3.**

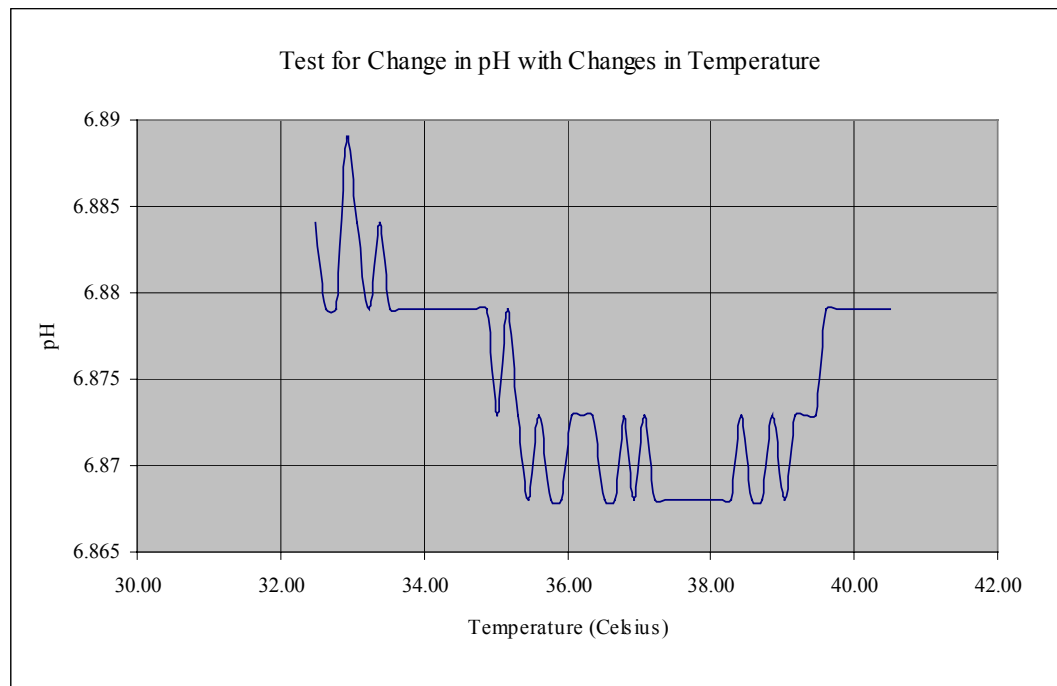




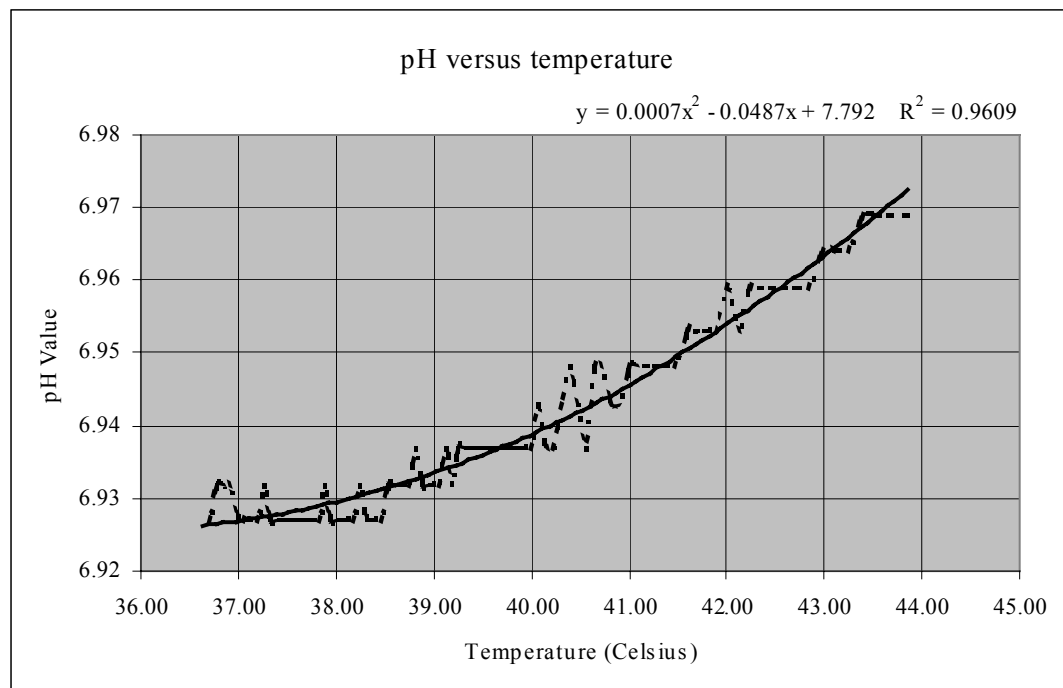
**Figure 7.3: Results of a typical long-term stability test (approximately 12.5 hours). The electrode is in a 7.0 pH buffer heated to 37 degrees Celsius in a water bath. The total drift is 0.008 pH units.**



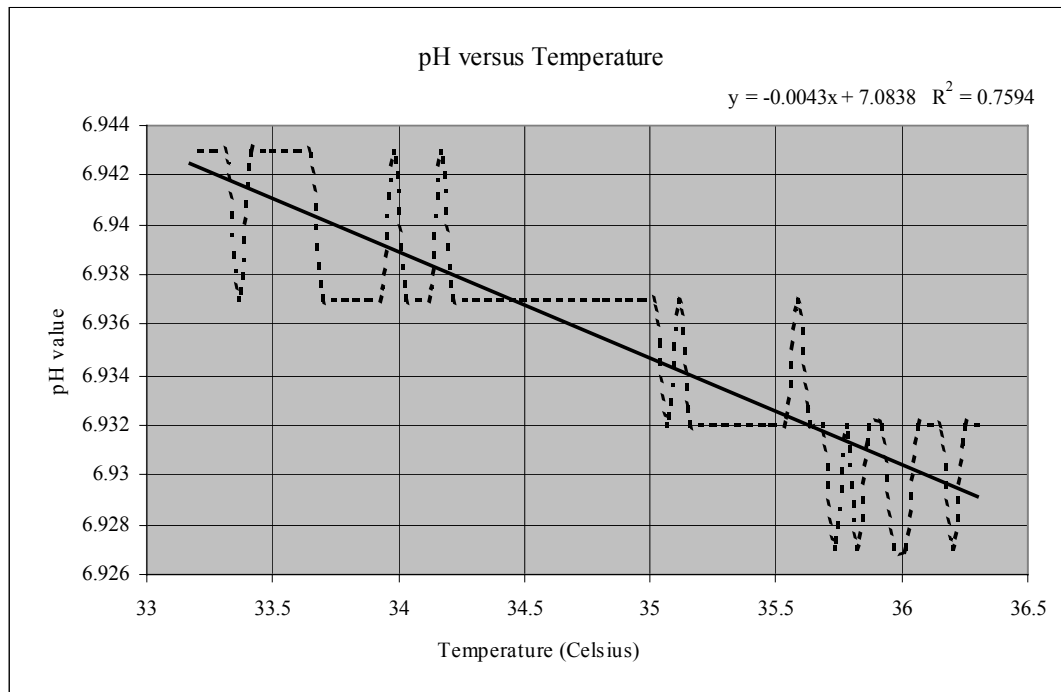
**Figure 7.4: Typical results of testing for stability while holding the electrode with the left and right hands against a sponge saturated with a 7.0 pH buffer.**



**Figure 7.5: Recorded pH versus temperature. The electrode was immersed in a 7.0 pH buffer while the temperature was regulated using a water bath.**



**Figure 7.6: Recorded pH versus temperature while electrode is in a 7.0 pH buffer. The dashed curve is the actual change in pH per change in temperature that the electrode reads. The black curve is a trendline fit to this curve.**



**Figure 7.7: Recorded pH versus temperature while electrode is in a 7.0 pH buffer. The dashed curve is the actual change in pH per change in temperature that the electrode reads. The solid curve is a trendline fit to this curve.**

## 7.2 Calibration of Electrodes

Each of the electrodes was calibrated at room temperature initially to attain an understanding of the voltages that will typically be obtained from the electrodes when immersed in a range of pH values. A graph of the calibration line helps to visualize how calibration characteristics are used to calculate a pH value from the voltage that is registered from the electrode. The characteristics include a slope and an intercept, which are used to form a straight line as can be seen in Figure 7.8. The slope and intercept are obtained by a two-point calibration, as described in section 6.2. Each pH value corresponds to a specific millivolt reading. For electrode number 64804, the x-intercept is 6.94 pH and the slope is  $-58.80$  mV/pH. The equation of this characteristic line is as follows:

$$\text{mV} = -58.80 \cdot \text{pH} + 407.92 \quad (7.1)$$

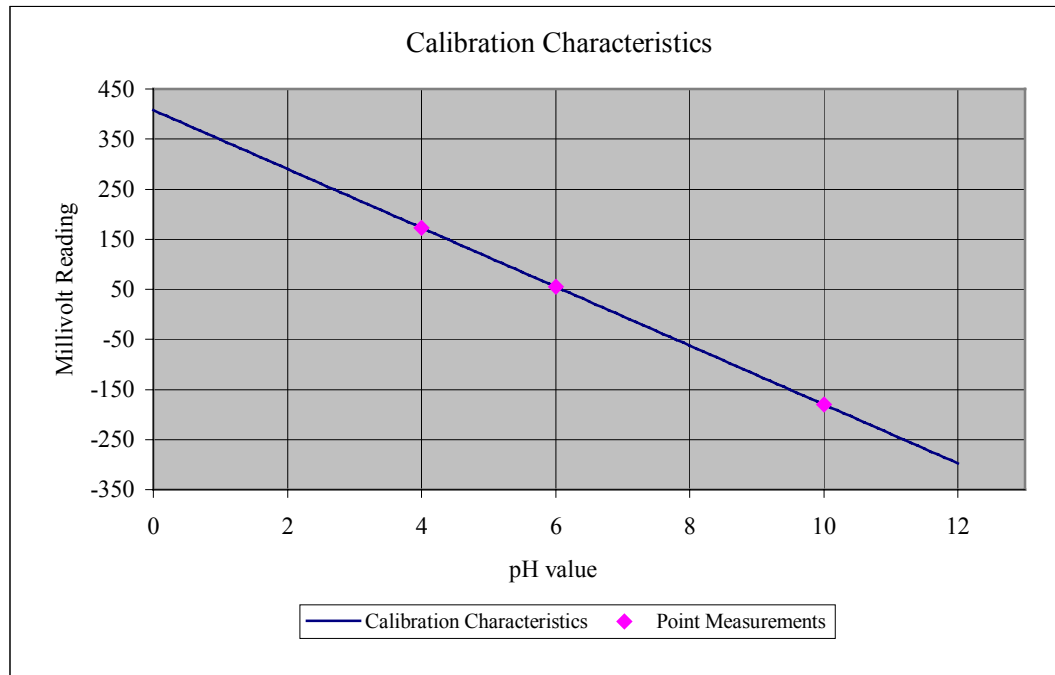
In theory, the relationship between the mV reading and the pH of the medium in question is linear. The millivolt reading at an additional point (pH of 6) was taken and plotted on the characteristic line to validate this linear relationship.

Table 7.5 shows the calibration characteristics for five electrodes. An average is calculated for the intercepts and slopes. These values are good estimates of the typical range of the calibration characteristics. The theoretical values of electrode calibration characteristics are  $-56$  mV/pH for the slope and 7.0 pH units for the x-intercept.

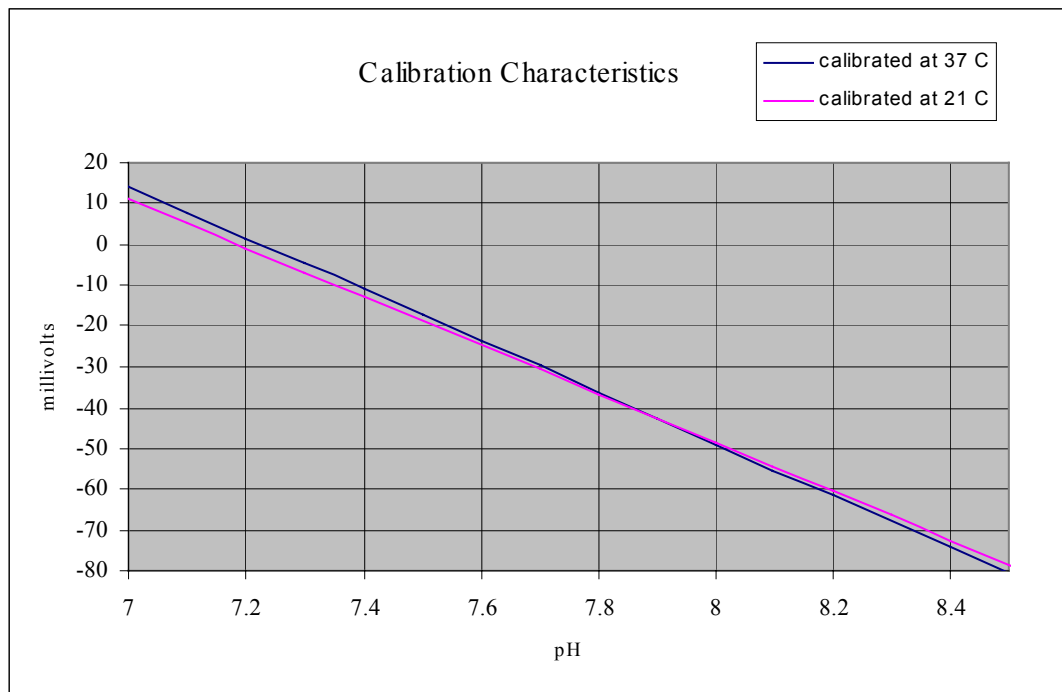
*Table 7.5: Calibration characteristics for MI-414 electrodes*

Electrode Number	X-intercept (pH units)	Y-intercept (mV)	Slope (mV/pH)
64804	6.94	407.92	-58.80
64233	6.23	325.97	-52.26
61931	6.98	391.31	-56.14
64236	7.23	434.27	-60.07
64241	6.69	374.92	-56.03
<b>Average</b>	<b>6.81</b>	<b>386.88</b>	<b>-56.66</b>

Next, the effects of calibrating the electrodes at different temperatures was explored. This is very important because if temperatures greatly affect the recorded pH, then calibrating at one temperature and measuring at another will cause erroneous measurements. Figure 7.9 shows the calibration characteristics for an electrodes at  $21^{\circ}\text{C}$  (room temperature) and  $37^{\circ}\text{C}$  (body temperature). The graph focuses on the region of interest on the pH scale for this research, which is in the seven pH unit range.



**Figure 7.8: Calibration curve for electrode # 64804. The calibration was performed using a 4 and 10 pH buffer. The voltage level of a 6.0 buffer was recorded to ensure that the characteristic line was properly calculated.**



**Figure 7.9: Calibration characteristics for electrode #64236 zoomed in to the region of interest, 7 to 8.5 pH units.**

### 7.3 Animal Studies Results

The animal studies involved a long process of determining the animal model that would produce the best and most accurate results. Problems arose that prevented the acquisition of accurate tissue pH data. In many cases, bacteria did not grow significantly, making some of animal trials useless. Once the model was improved, data was collected and analyzed. The results obtained with the different models that were presented in the chapter on methods will be discussed in the Discussions chapter. This section will present the cumulative results acquired from all of the models, and then an analysis of the results that were achieved using the best animal model.

A summary of the animal models that were used throughout the animal study and notes on the results that were attained is presented in Table 7.6. Digital photographs were taken of several of the animal models and infected wounds. Figure 7.10 shows the preparation of a rat using model one (see Section 6.3.1.1) and a wire mesh covering (see Section 6.3.2). Figure 7.11 is a picture of a wound that produced relatively high levels of bacteria, on the order of  $10^6$  bacteria counts/gram tissue. Figure 7.12 shows the method of stapling that rat's skin. This method worked best for securing the wound during the incubation time. Finally, Figure 7.13 displays the positioning of the created wounds on the dorsal, medial area of the rat's body. Model two was used in the preparation of this wound (see Section 6.3.1.2). Each of the models will be discussed in section 8.3.

#### 7.3.1 Cumulative Results of Animal Tests

Nine separate animal studies were performed over the course of six months with a total of forty animals. The number of rats used in each of the studies and the number of measurement points acquired per rat were limited by the microlab at UMMC which would not accept a significant number of biopsies to be cultured at one time. Figure 7.14 is a scatter plot of all the tissue pH data that was acquired during the course of these nine studies. Figure 7.15 is a frequency histogram of all the data. It shows the variation of tissue pH measurements that were found among the rats that were tested. It can be seen that a majority of the data lies in the range of 7.1 to 7.5 pH units.

#### 7.3.2 Analysis of Relationship between Tissue pH Levels and Bacterial Contamination

Due to the obstacles encountered in developing a good animal model, eighty-three data points were acquired that are usable for analysis. This number of measurement points is not large enough to determine a statistically significant correlation between tissue pH and bacteria levels, but they can be used to determine whether or not the research's hypothesis is feasible.

Figure 7.16 displays the measurements points from the last four animal studies. The data plotted along the y-axis represent differential measurements, and is calculated using the following equation:

$$\text{pH}_{\text{Differential}} = \text{pH}_{\text{Infected}} / \text{pH}_{\text{Healthy}} \quad (7.2)$$

where the healthy tissue pH measurement was taken from each rat. This allows for a comparison to be made between different rats. The x-axis shows the bacteria counts times  $10^5$ . A trendline is fit to the data with a low  $R^2$  value of 0.23.

Figure 7.17 shows the data from the last three animal trials. Only the measurement points that had greater than  $1 \times 10^4$  bacteria counts/gram tissue were graphed here. We are not concerned with data points that exhibited less than  $1 \times 10^4$  bacteria counts/gram tissue because this level of contamination is not considered an infection. A trendline is fit to the data points and is described by the following equation:

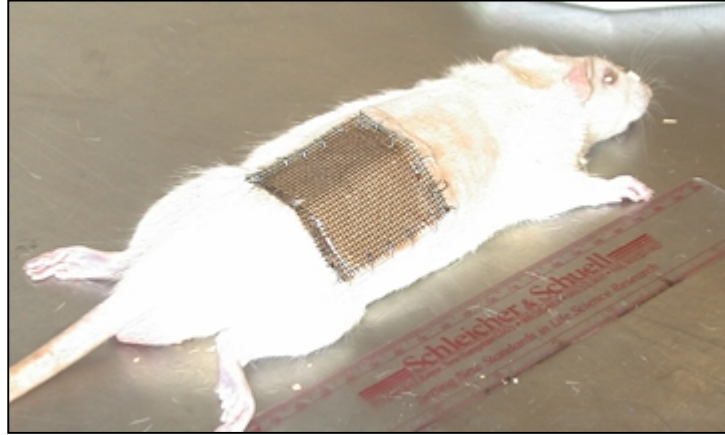
$$y = -0.0032x + 0.9947 \quad (7.3)$$

where the independent variable,  $x$ , represents the bacteria counts and the output,  $y$ , represents the differential tissue pH. The  $R^2$  value for this trendline is 0.57. Again the lack of data points with greater than  $1 \times 10^6$  bacteria counts/gram tissue makes it difficult to determine a linear trendline that is statistically significant.

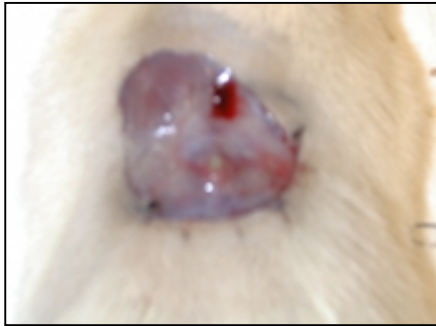
*Table 7.6: Overview of the methods used for each animal study*

#	Rats	Bacteria counts/ mL	Incubation Time	Method	Notes
1	5	$2 \times 10^2$	24 hour	Incised and removed skin from lateral, dorsal area of rat; Secured with plastic cup and wrap.	Gram negative bacteria counts did not appear in all biopsies. The counts were low and many of the bandages were chewed off making the acquisition of tissue pH difficult.
2	5	$2 \times 10^5$	24 hour	Incised and removed skin from lateral, dorsal area of rat; Used a standard bandage.	Bacteria levels were higher but a linear relationship between the bacteria levels and tissue pH was not apparent. Many of the bandages were chewed off.
3	5	$2 \times 10^7$	48 hour	Incised and removed skin from lateral, dorsal area of rat; Used a bandage and wire mesh.	Rats still attacked bandages. Bacteria levels were $10^5 - 10^6$ . Exposed tissue dried up, interfering with pH measurements.
4	5	$2 \times 10^7$	48 hour	Incised three sides of square on lateral, dorsal area of rat; Stapled skin flap.	This technique of securing the wound did not bother the rats nearly as much. The bacteria levels were low, and no gram negative counts were seen.
5	3	$1.8 \times 10^8$	48 hour	Placed wound on upper back; Incised two sides of square, injected bacteria, and secured by stapling skin.	The location of the created wound was very good. The rats were not bothered by the presence of the staples. The bacteria levels were low.
6	2	$2 \times 10^8$	72 hour	Same as animal study 5	The bacteria levels were higher (clinically infected). The pH levels corresponded well. This method of preparing and securing the wound appears to be the most appropriate.
7	5	$2 \times 10^8$	72 hour	Same as animal study 5	The bacteria levels ranged from $2 \times 10^2$ to $2 \times 10^6$ . A weak correlation between bacteria and pH levels can be seen.
8	5	$2 \times 10^8$	72 hour	Same as animal study 5	The bacteria levels ranged from $5 \times 10^2$ to $1.5 \times 10^6$ . A decreasing trend is apparent for pH measurements versus bacteria counts (greater than $5 \times 10^4$ ).
9	5	$2 \times 10^8$	96 hour	Same as animal study 5	The bacteria levels ranged from none to $3 \times 10^6$ . Again, a decreasing trend is seen in the pH versus bacteria but a lack of points with high bacteria levels makes the relationship difficult to ascertain.





**Figure 7.10: Preparation of a rat using model one and a wire mesh covering. The created wound was inoculated with  $2 \times 10^5$  bacteria counts/mL.**



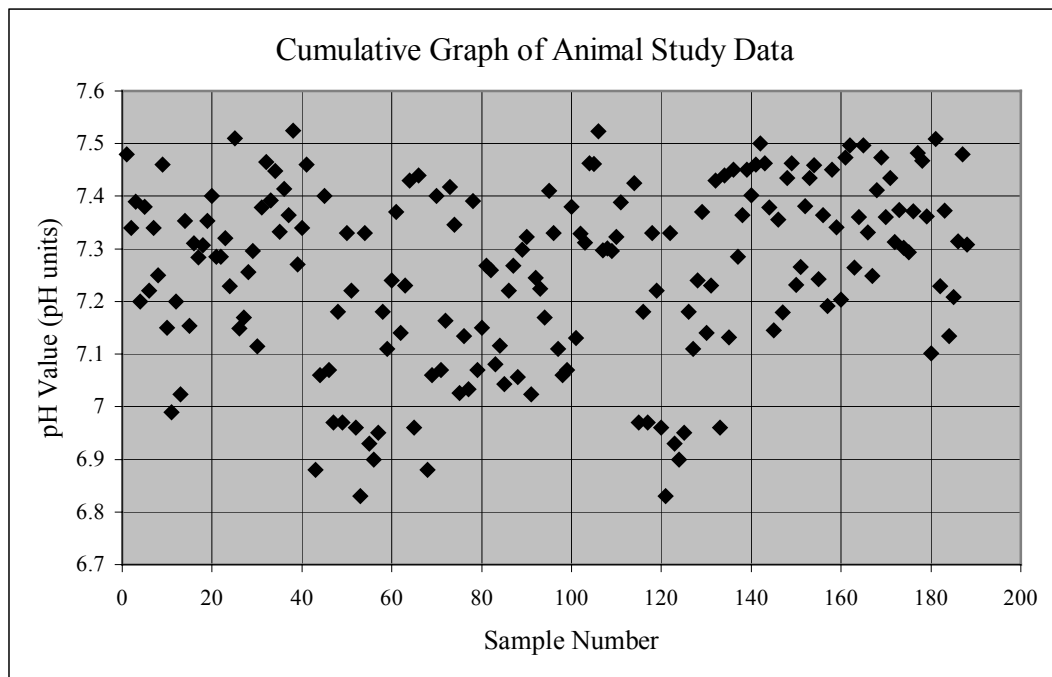
**Figure 7.11: Infected wound. Incubation time of 72 hours. Created wound was infected with  $2 \times 10^8$  bacteria counts/mL.**



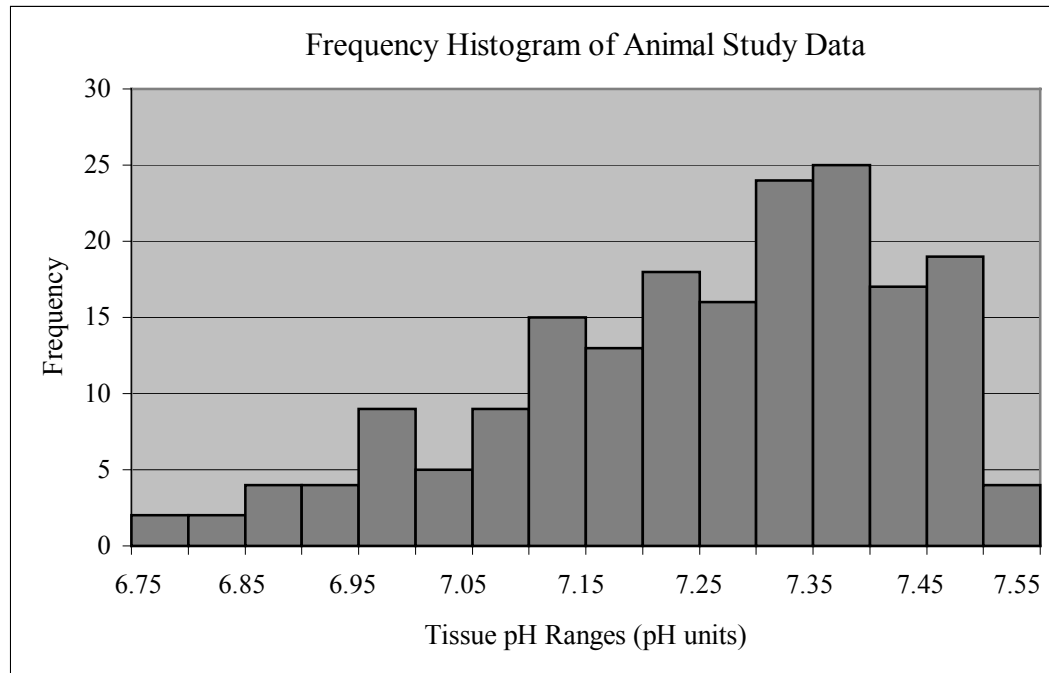
**Figure 7.12: Method of stapling rat's skin after inoculation.**



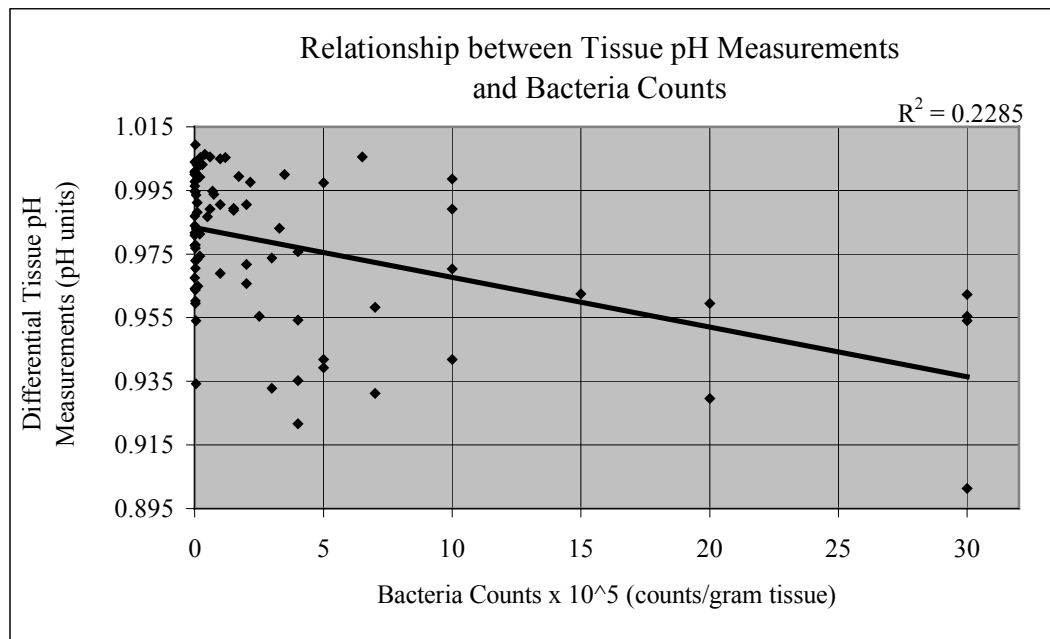
**Figure 7.13: Infected wound using model two. The skin had been stapled, and the rat was not bothered by the presence of the wound during the incubation time.**



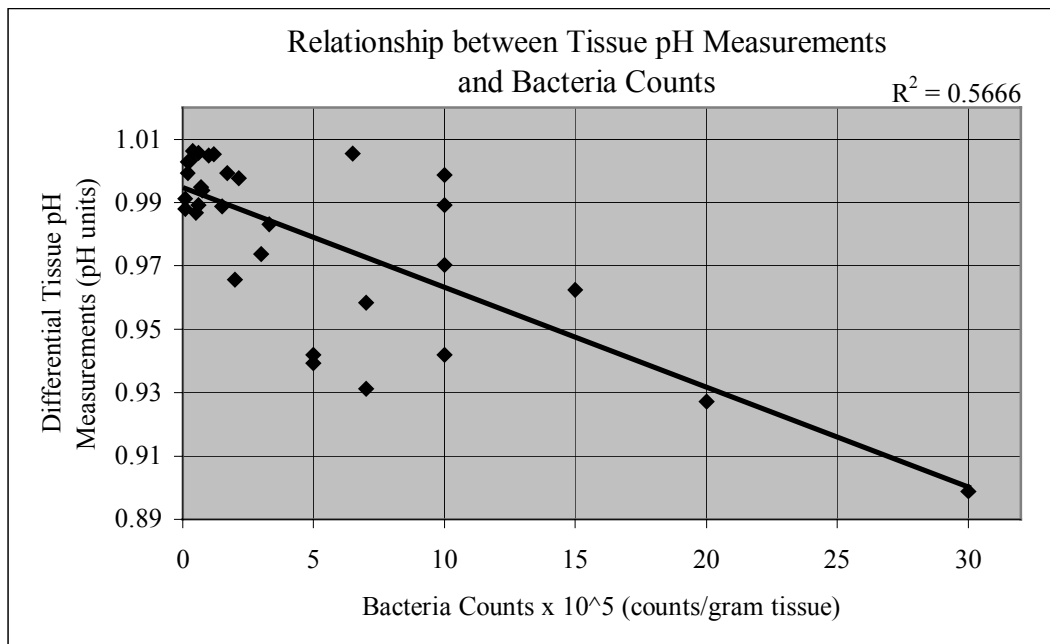
**Figure 7.14: Scatter plot of all the data points acquired during animal testing. Forty rats were tested producing 188 measurement points. Due to problems with the animal model, only 44% of this data was used for analysis.**



**Figure 7.15: Frequency histogram of all the animal study data. Forty rats were tested with a total of 188 points.**



**Figure 7.16:** Data from last four animal studies (all using the same animal model). The y-axis displays the differential measurement (tissue pH/healthy tissue pH) and the x-axis displays the bacteria counts/gram tissue. Eighty-three measurement points are shown here.



**Figure 7.17:** Relationship between tissue pH measurements from the last three animal studies and bacteria levels greater than  $1 \times 10^4$  counts/gram tissue. The y-axis displays differential measurements (pH measurement/healthy tissue pH measurement for each rat). The x-axis is bacteria counts times  $10^5$ . Thirty-two measurement points are shown here.

## 7.4 Clinical Study Results

The clinical testing was performed over a period of three months. A total of sixty-three tissue pH measurements and ten bacterial cultures were acquired from sixteen wounded on ten patients. Several patients possessed multiple isolated wounds. The acquired tissue pH data and bacteria counts, together, indicate the health of the wound tissue. Because of the discomfort and harm that could be caused to the patient, numerous quantitative cultures could not be taken from the patients. Thus, these results will not yield enough quantitative information to assess a concrete relationship between tissue pH bacteria levels and bacterial contamination; yet, because no one has previously acquired tissue pH measurements from several points in a wound, the results present a substantial scientific contribution.

### 7.4.1 Patient Information

Several different kinds of patients were examined, including inpatients, outpatients, and surgical patients. These patients had a variety of ailments ranging from acute wounds caused by trauma, to chronic ulcers that have existed for up to six years. The number of measurements taken from each of the patients depended on the patient's situation and the location in the hospital at which he/she was located. Very few measurements were taken from outpatients because they were seen in the clinic; thus, the patients as well as the doctors were on a tight schedule. The largest amount of measurements was acquired from each of the inpatients because they were bedridden. A fair number of points were measured on each of the surgical patients' wounds. Again, during these cases, the priority is to perform services to the patient in a timely fashion.

Several pieces of information were collected from each of the patients. This will give us a good background on each of the cases. Table 7.7 displays a summary of the personal information that was obtained from each patient. Each patient was assigned a number to keep his/her identity confidential. Table 7.8 includes background on each of the patients' wounds (age of wound from initiation, type, and location). From the information contained in Tables 7.7 and 7.8 and from observations made at the time of testing, a description of each patient can be developed.

*Table 7.7: Summary of patients' personal information to provide background on patient status*

Patient Number	Patient Type	Age/Gender	Race
1001	Out	52/M	Caucasian
1002	Out	63/F	Hispanic
1003	Out	56/M	African American
1004	Out	32/M	African American
1005	In	82/M	Caucasian
1006	In	46/F	African American
1007	Out	79/F	Caucasian
1008	Surgical	32/M	Caucasian
1009	Surgical	43/M	Caucasian
1010	Surgical	20/F	Caucasian

Table 7.8: Summary of wound information to provide background on wound status.

Patient Number	Wound Age	Wound Type	Wound Location
1001	7 months	venous ulcer	Left medial lower leg
1002	---	venous ulcer	Right and left lateral lower legs
1003	6 years	venous ulcer	Left lateral lower leg
1004	1 year	pressure ulcer	Upper posterior legs
1005	---	ischemic/vasculitic ulcer	Anterior lower legs
1006	1 month	infection/open wound/trauma	Lower left arm
1007	---	saphenous vein leg harvest wound	Left medial leg and thigh
1008	---	trauma	Right foot
1009	< 1 month	burns	Both legs
1010	< 1 month	trauma	Right medial lower arm

Patient 1001 is an outpatient who has venous ulcers that overlaid an ulcer that had been skin grafted previously. He underwent tissue transfer six years before, and new wounds have developed since that time. The patient experiences pain when walking and visits the outpatient clinic quite frequently. Figure 7.18 shows a picture of this patient's wounds. The outline of the existing ulcer can be seen. The wounded areas that are labeled were measured. The patient commented that he could not feel any discomfort while testing occurred.

Patient 1002 is an outpatient and has venous ulcers located on both lower legs. The tissue was exposed and surrounded by an abundance of necrotic skin. This patient was very sensitive and moved her legs when the electrode was placed on the tissue, which affected the tissue pH measurements. Figure 7.19 displays the area of the patient's leg that was measured.

Patient 1003 has been an outpatient for several years. He has venous ulcers on both of his lower legs and wears a leg boot as part of his treatments. He has had wounds in this area for the past 28 years. Several small areas of tissue were exposed and these were the sights at which the tissue pH measurements were taken. The wounded areas that were measured can be seen in Figure 7.20. The patient did not experience any discomfort during testing.

Patient 1004 is an outpatient who has pressure ulcers on the upper leg and buttocks. These wounds were fairly deep, and the patient was in a substantial amount of pain. A large portion of the patient's wounds were not receiving sufficient blood supply, making the tissue appear whitish. Measurements were taken from areas of the wound that possessed some fluid. A photograph of the wound can be seen in Figure 7.21.

Patient 1005 is an inpatient who has severe chronic wounds, ischemic/vasculitic ulcers, on both lower legs. The wounded area extends from the medial to lateral side of each lower leg on the anterior side. The wounds were deep; the tibia is exposed on both legs, and an abundance of necrotic tissue was apparent. The wounds on the left leg extend over an area of about 3 by 2 ½ inches; the right leg wounds cover about 9 by 1 ½ inches. The patient is unable to walk and is in a lot of pain. Several areas of the wound

were sensitive to the touch of the electrode. Figures 7.22 through 7.24 display digital images of the wound.

Patient 1006 is an inpatient who has a wound that resulted from an infection/trauma on her lower left arm. The patient was in considerable pain but was patient while testing was performed. The wound is approximately 6 by 5 inches in area, extending the length of the patient's lower arm (see Figure 7.25). The patient is receiving antibiotic treatments on the wound surface; these were removed prior to testing.

Patient 1007 is an outpatient who has three wound: one larger on the lower, medial left leg and two smaller ones on the left thigh (see Figures 7.26 – 7.27). They are saphenous vein harvest wounds. The larger wound is mostly reddish in appearance, while the other two wounds are whitish, indicating their unhealthiness. There was an abundance of fluid in these wounds, making it easy to acquire stable tissue pH measurements quickly. The patient did not feel any discomfort during the testing.

Patient 1008 was a surgical patient who was receiving a tissue transfer on his right foot. A portion of his right foot was gone due to frost bite, and a large area of reddish tissue was present (see Figure 7.28 and 7.29). The tissue transfer was being taken from the patient's left thigh.

Patient 1009 was a surgical patient with 3<sup>rd</sup> degree burns on thirty percent of his body. He was involved in a traumatic experience that caused these burns. The leg that was measured can be seen in Figures 7.30 and 7.31. The tissue appearance ranged from reddish to black (necrotic tissue). Only four points were measured because the surgeons were beginning the surgical procedure.

Patient 1010 was a surgical patient who experienced an acute trauma, causing a large open wound on her lower right arm. Variable depths of tissue were apparent. Figure 7.32 shows the wounded area. The patient was receiving a tissue graft from her right thigh to close the wound. Prior to this surgery, a portion of the wound was closed by stapling. The wound was deep and contained a good amount of necrotic tissue.

#### **7.4.2 Cumulative Results of Clinical Testing**

To get a sense of the values that were acquired during the clinical testing, a scatter plot was created of all the tissue pH measurements acquired during clinical testing (see Figure 7.33). This plot displays the pH values versus the sample number; the data from each patient is displayed directly after the other. A total of sixty-three points were acquired from ten patients. It can be seen that the tissue pH values range from approximately 6.8 to 7.6; yet, a majority of the points lie between 7.1 and 7.55. The mean of these data points is 7.33 pH units, and the standard deviation is 0.17 pH units. Another interesting statistic is the average of the absolute deviations from the mean which is 0.13 pH units.

Figure 7.34 displays a frequency histogram of the entire data set. This gives another illustration of where the data lies and what values are typical of wound tissue pH. It can be seen that a majority of the points lie between 7.3 and 7.4 pH units. Figure 7.35 shows another frequency histogram with a step size in the pH value range of 0.05 as opposed to 0.1 pH units. A majority of the pH data falls between 7.15 and 7.55 pH units, the maximum being between 7.35 and 7.40 pH units. Healthy tissue pH usually falls between 7.38 and 7.44 pH units. The next graph, the stratified plot seen in Figure 7.36,

looks at the data in a different way. The data points are separated by case so that the between and within variation of the data can be visualized.

#### **7.4.3 Analysis of Relationship between Tissue pH Levels and Bacterial Contamination**

In order to ascertain whether the tissue pH level of a patient's wound is a good indication of the tissue's health and bacterial contamination, the data from each of the patients who were tested must be reviewed. We would like to get a sense of how the tissue pH, bacterial contamination, wound appearance, and wound location correlate. The pictures of each of the wounds (Figures 7.18 to 7.32) contain the tissue pH measurement values that were taken at each point. In the corresponding sections of the Discussions chapter, the importance of the location of the tissue pH measurements is explained.

To attain a sense of the bacterial contamination that is present in the patients' wounds, swab cultures or quantitative cultures were taken from all of the patients except the first. Quantitative cultures could not be taken from the outpatients because these wounds are chronic, and further loss of tissue would be detrimental to their condition. Therefore, a cotton swab was touched to the surface of the tissue and cultured to get a qualitative count of the bacteria level. Biopsies were taken from inpatient and surgical patients to obtain a quantitative measure of the bacteria present.

Table 7.9 displays the information that was acquired about the bacteria levels in the patients' wounds. It also includes the average tissue pH level, standard deviation, and number of valid measurements for each patient case. Average tissue pH levels were calculated for each isolated wound and are separated by commas in the table. Similarly, the number of measurements from each of the patients' wounds correspond to these averages. For example, patient 1005 had wounds on his right and left legs. The average of the tissue pH measurements on his left leg, from 7 measurements was 7.40. The average tissue pH level from his right leg wound is 7.32 (calculated from 9 measurements). The standard deviation was calculated from all the measurements acquired from each patient. The average tissue pH of all the measurements is 7.31 with a standard deviation of 0.12 pH units.

From this table, the tissue pH and bacterial contamination levels can be related. First, the measures of bacterial contamination must be standardized. Because there are no quantitative bacteria counts for a majority of the patients, the bacteria counts for patients 1008 through 1010 will be translated into qualitative descriptions. Dr. Dunn was questioned on this matter. He related that a level of  $1 \times 10^4$  colonies/gram is approximately equivalent to a reading of few to moderate bacteria while a count of  $2 \times 10^6$  colonies/gram tissue relates to a significant amount of bacteria. Patients who have the same description of bacteria growth were analyzed for the number of organisms that were detected and the relative level (one through five) of these organisms. Figure 7.37 displays a graph of the average tissue pH levels for patients 1002 through 1010 versus a qualitative measure of the bacterial contamination present in their wounds. A culture was not taken from patient 1001; thus, he is not included in this analysis. It can be seen that the data can be fit to a linear trendline with a  $R^2$  value of 0.458.

*Table 7.9: Bacteria counts, average tissue pH level, standard deviation, and number of valid measurements from each patient. Descriptions of bacterial contamination signify a swab culture and values  $\times 10^n$  indicate quantitative biopsies.*

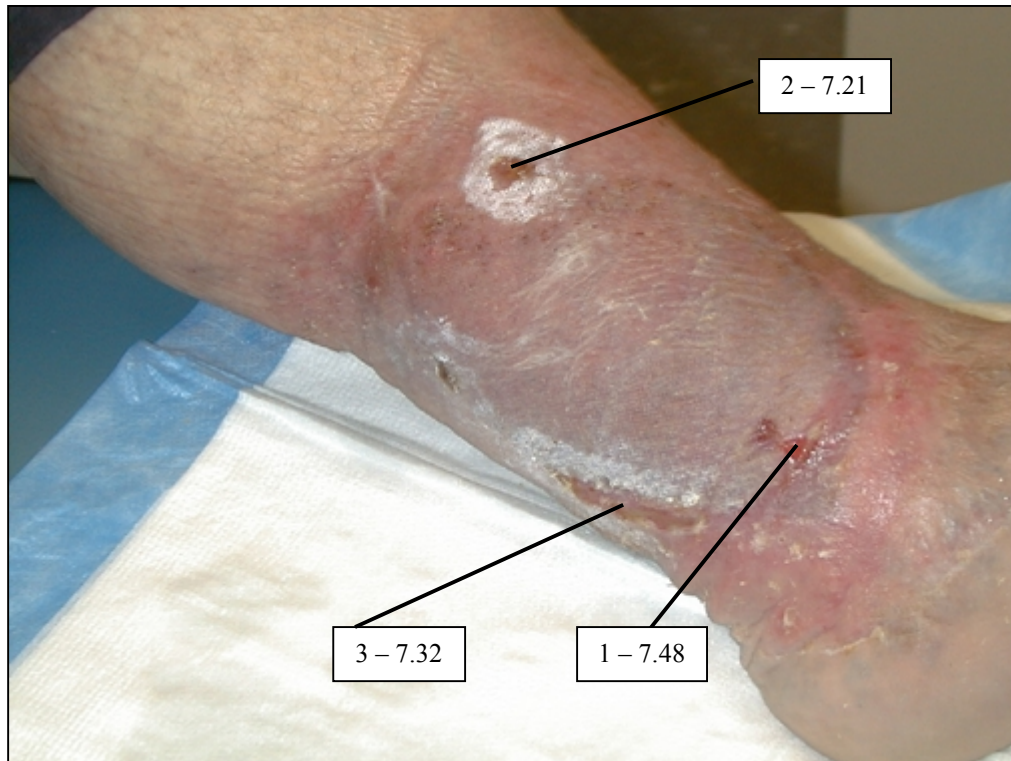
Patient Number	Bacteria Counts or Description	Average Tissue pH (pH units)	Number of Measurements	Standard Dev. (pH units)
1001	---	7.48, 7.21, 7.32	1, 1, 1	N/A
1002	moderate	7.43	2	0.061
1003	few	7.54, 7.48	1, 2	N/A
1004	rare	7.29	2	0.161
1005	few	7.40 (left), 7.32 (right)	7 (left), 9 (right)	0.113, 0.143
1006	no growth	7.42	15	0.127
1007	moderate, no growth	6.85, 6.86, 7.41	1, 1, 1	N/A
1008	$1 \times 10^4$ colonies/gram	7.24	6	0.095
1009	$1 \times 10^4$ colonies/gram	7.27	4	0.109
1010	$2 \times 10^6$ colonies/gram	7.19	7	0.175

#### **7.4.4 Tissue pH Variations within the Wound**

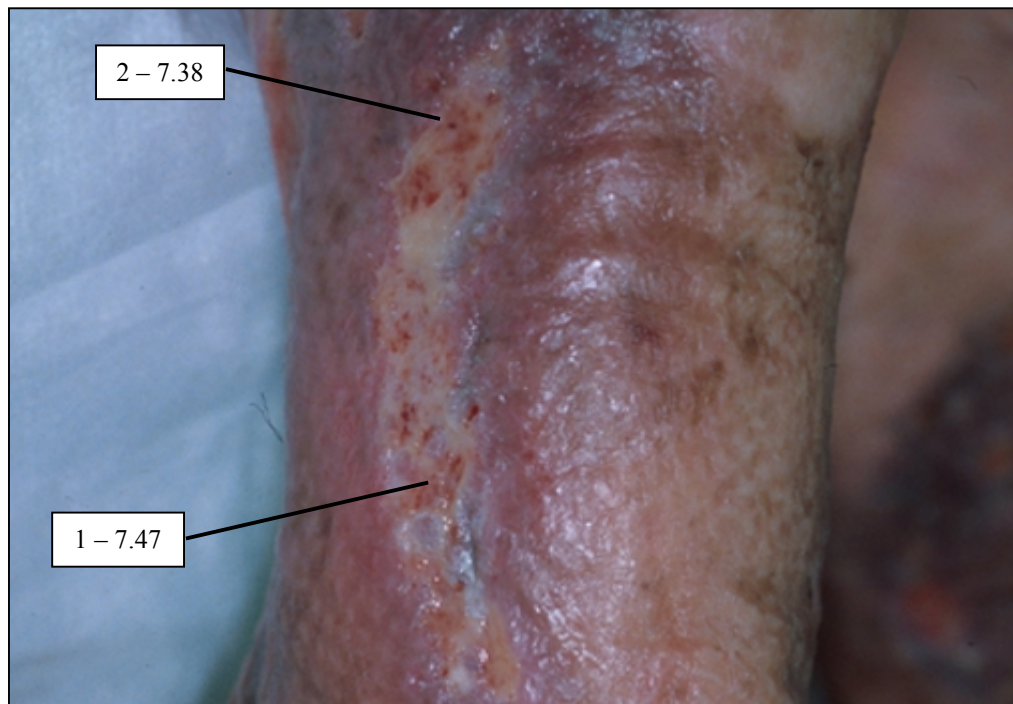
In several of the patient cases, enough measurements were taken to get a sense of the variation of tissue pH levels within the wound. Here, two cases will be reviewed. Contour plots were created in Mathcad. Figure 7.38 shows the contour plot of patient 1010's wound tissue pH levels. A color code is also included in order to understand the tissue pH levels that correspond to each shade of color. The plot is set up so that the top part of the plot corresponds to the top part of the digital image of patient 1010's wound (Figure 7.32), and a rectangle was best fit to the wounded area.

Figure 7.39 shows a contour plot of patient 1006's wound (see Figure 7.25). In this plot, the top part of the plot corresponds to the medial side of the patient's arm and the bottom part of the plot corresponds to the lateral side. Picture the rectangular plot overlaid on the patient's arm. The variations of tissue pH are indicated by the difference in colors, which represent tissue pH levels.

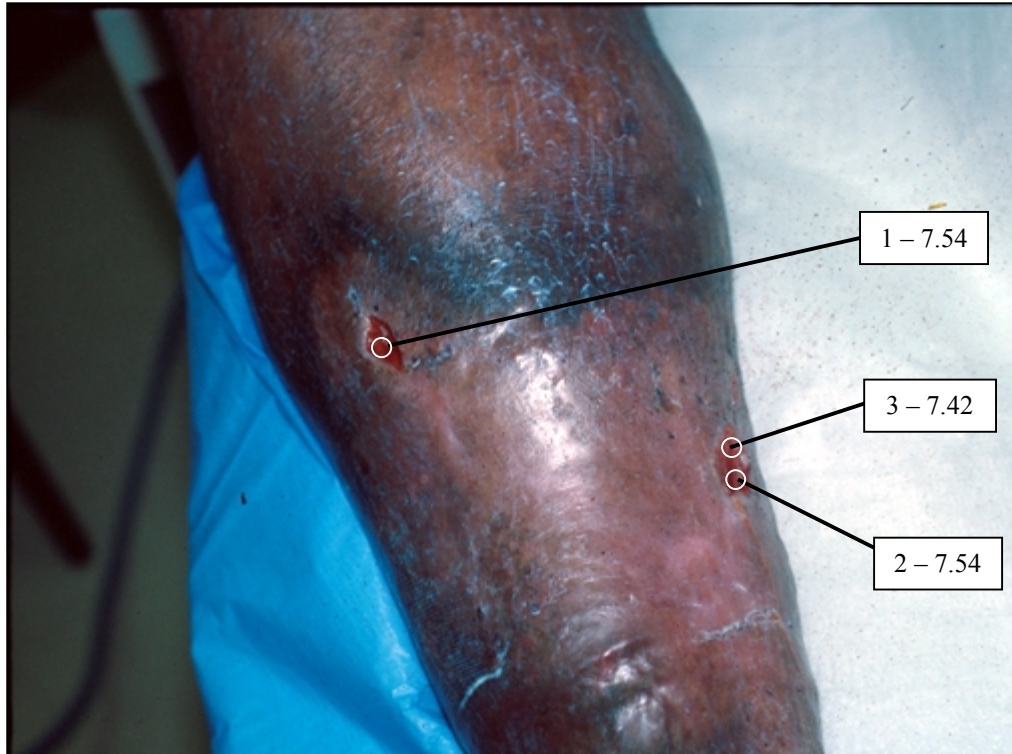




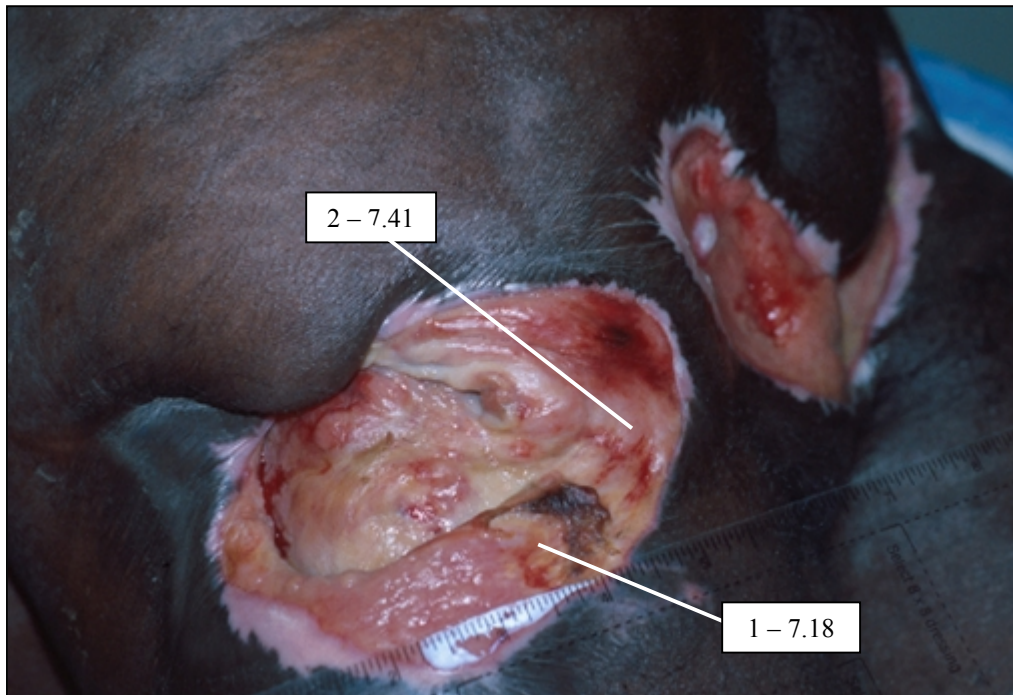
**Figure 7.18: Patient 1001's left medial leg**



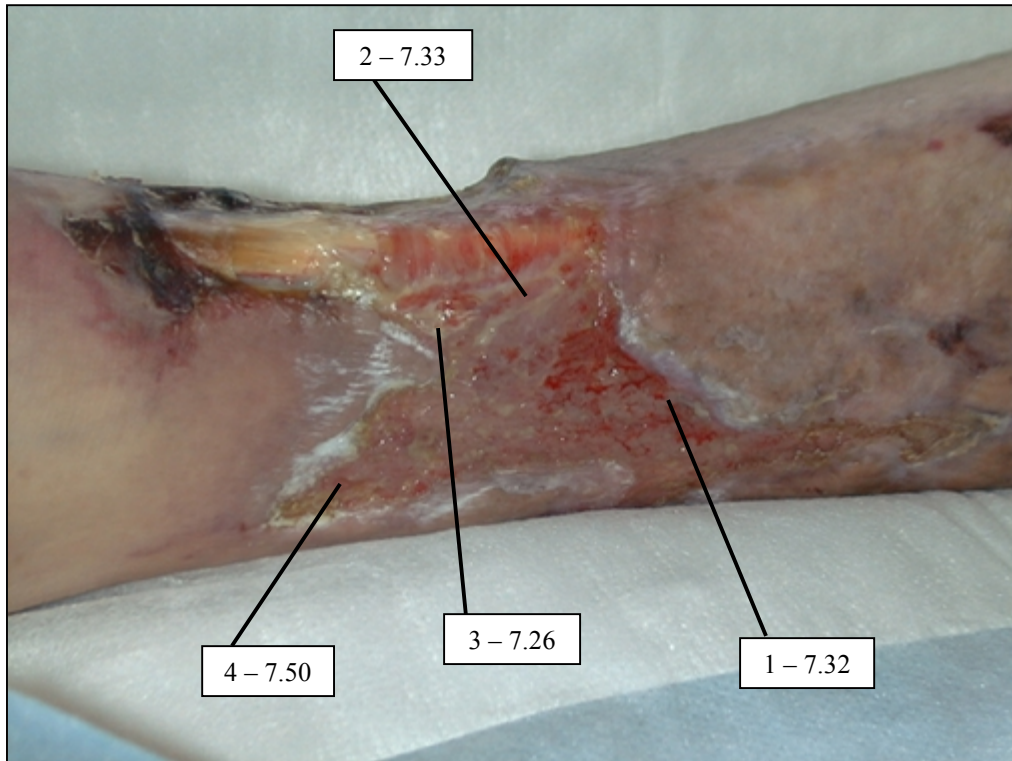
**Figure 7.19: Patient 1002's lateral right leg**



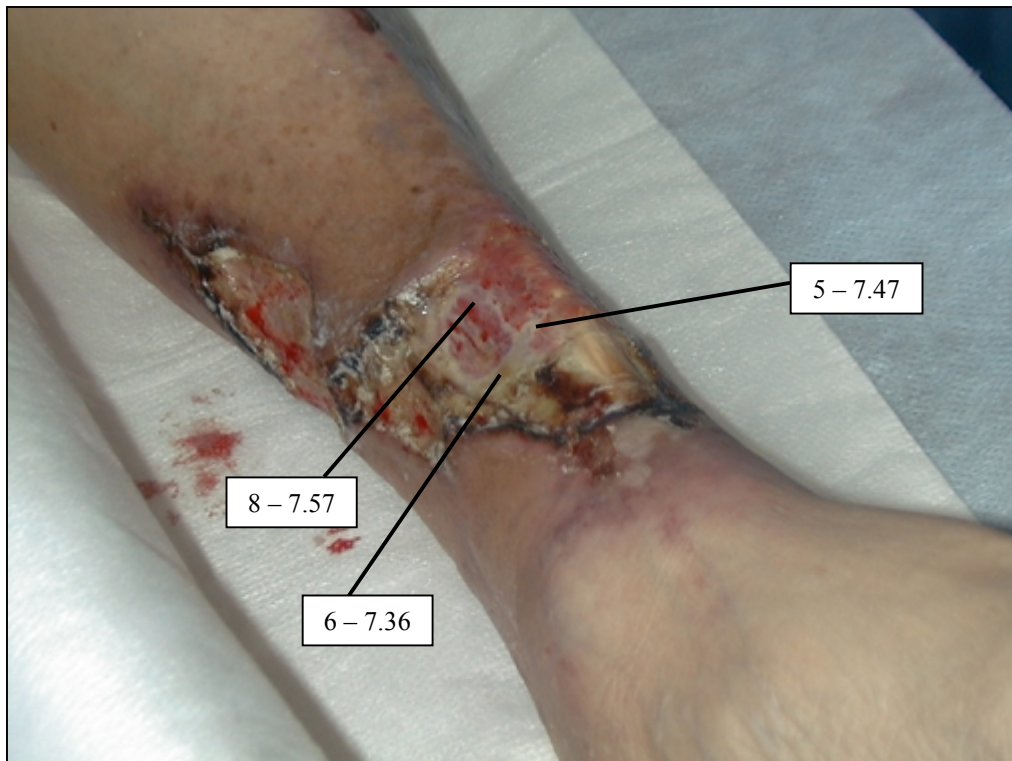
**Figure 7.20: Patient 1003's left anterior leg**



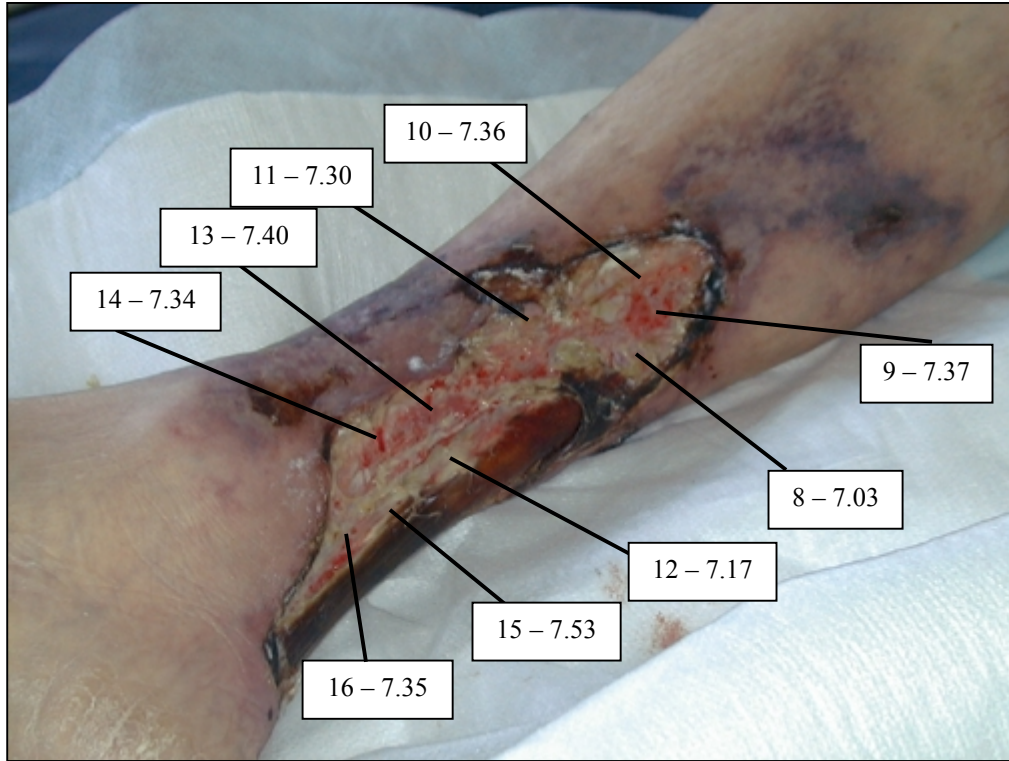
**Figure 7.21: Patient 1004's behind**



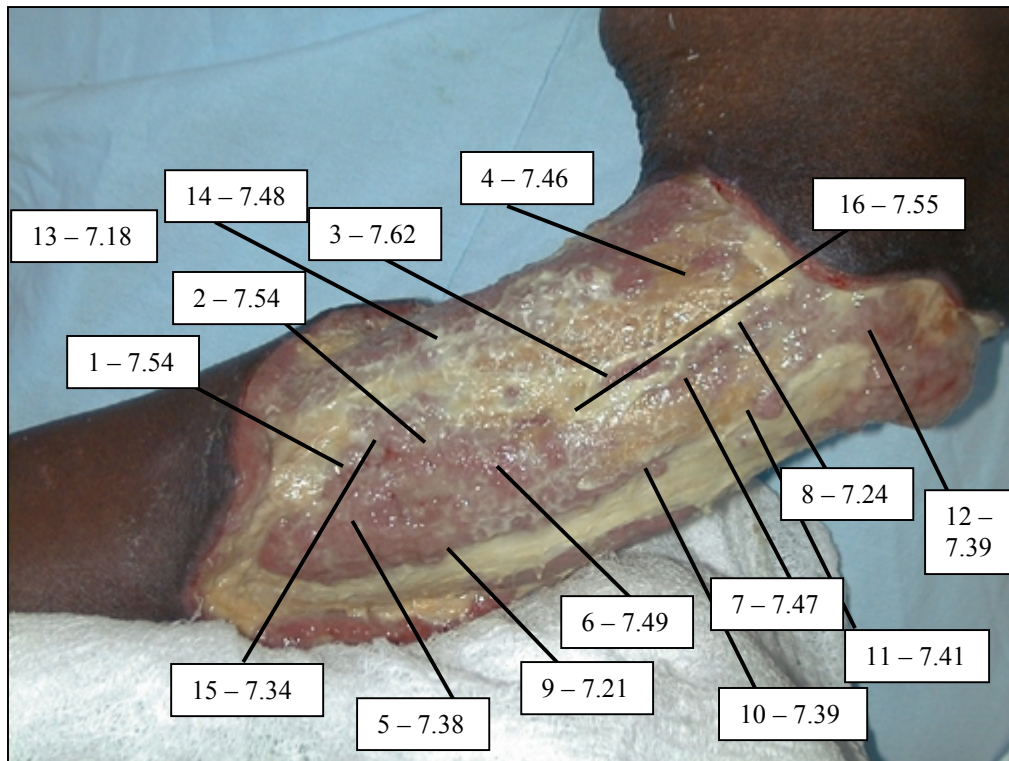
**Figure 7.22: Patient 1005's left lateral leg**



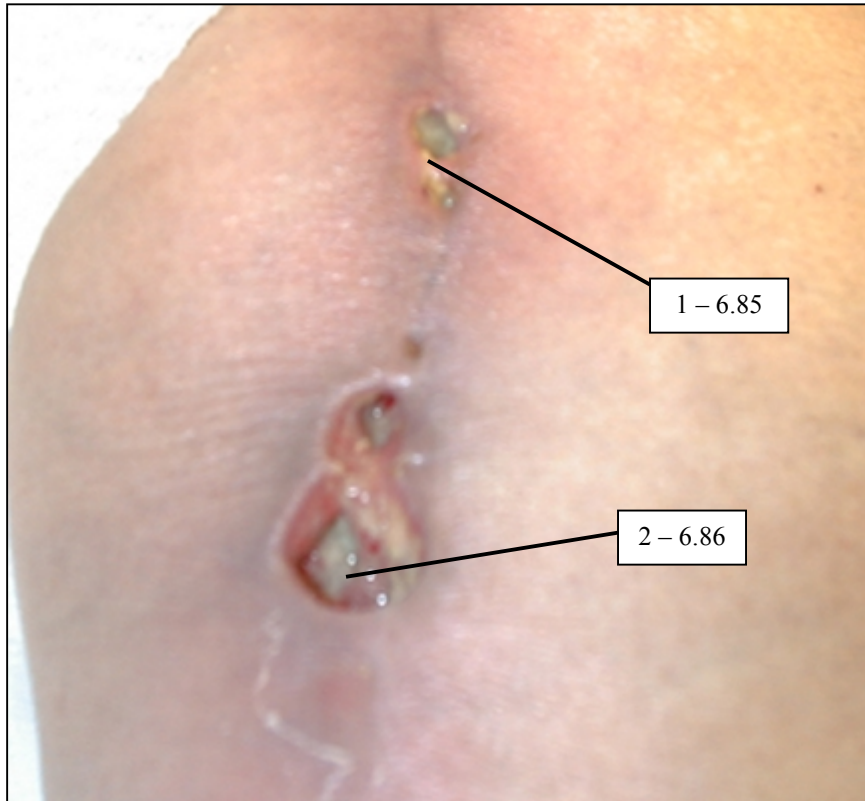
**Figure 7.23: Patient 1005's left medial leg**



**Figure 7.24: Patient 1005's right medial leg**



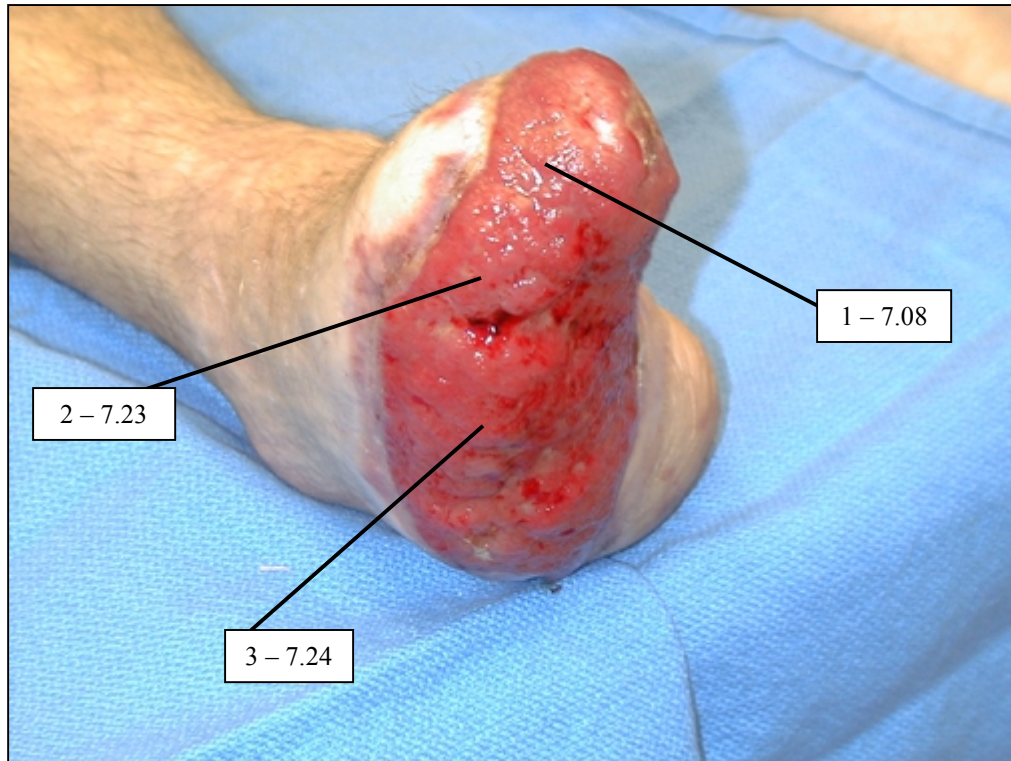
**Figure 7.25: Patient 1006's left lateral lower arm**



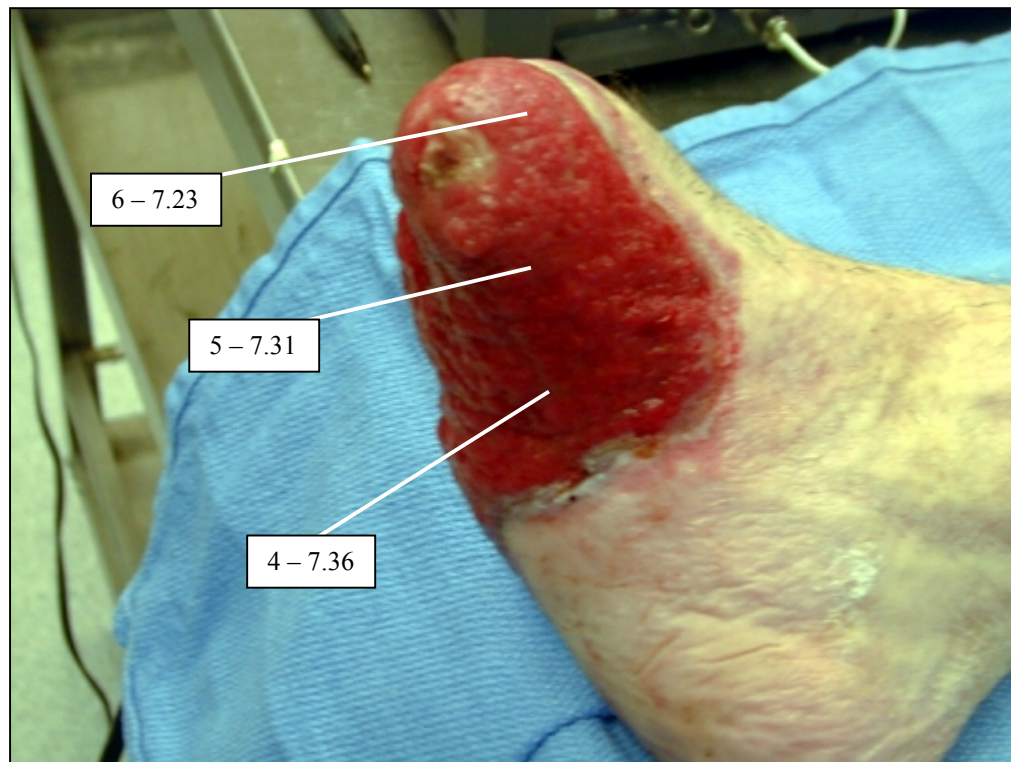
**7.26: Patient 1007's left medial thigh**



**Figure 7.27: Patient 1007's left medial lower leg**



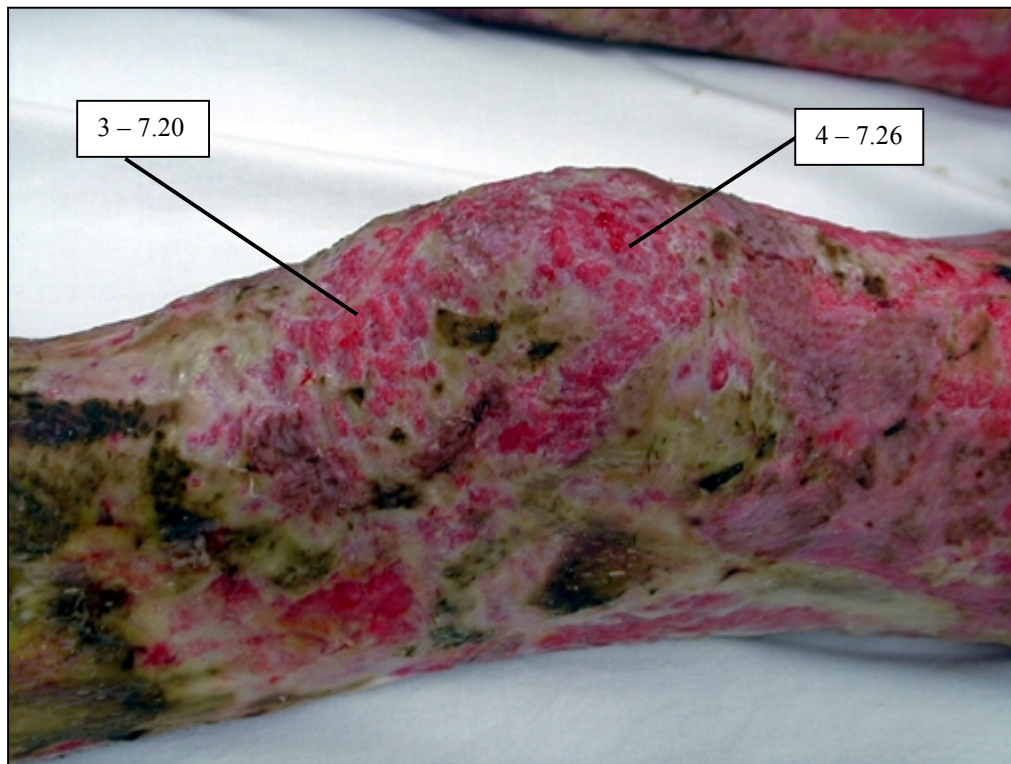
**Figure 7.28: Patient 1008's right foot**



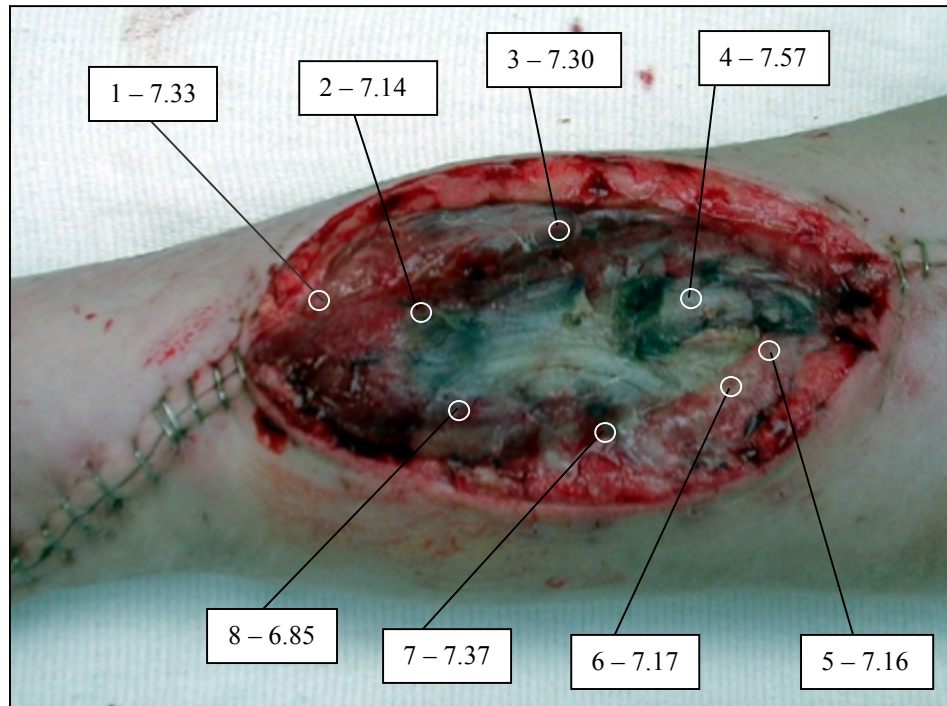
**Figure 7.29: Patient 1008's right foot**



**Figure 7.30: Patient 1009's left leg**

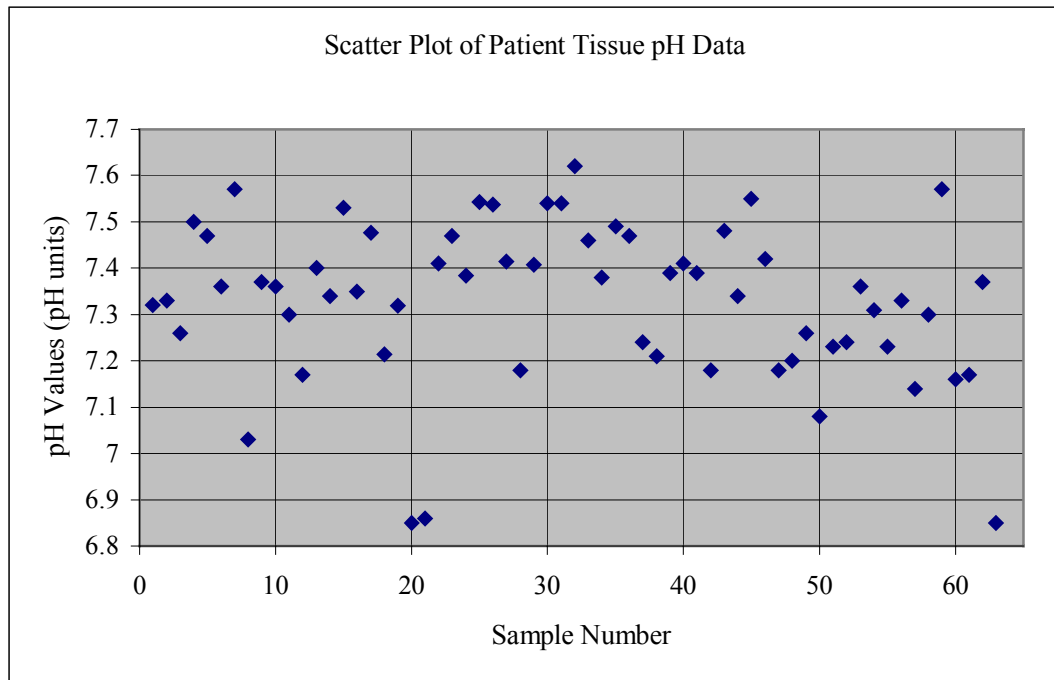


**Figure 7.31: Patient 1009's left knee**

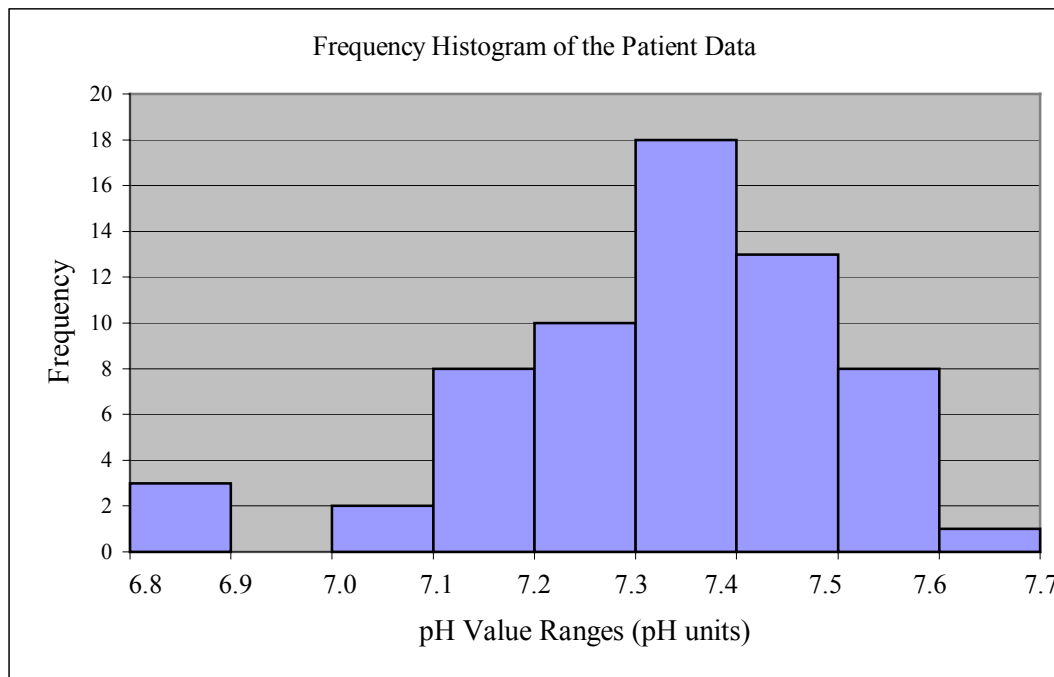


**Figure 7.32: Patient 1010's right medial arm**

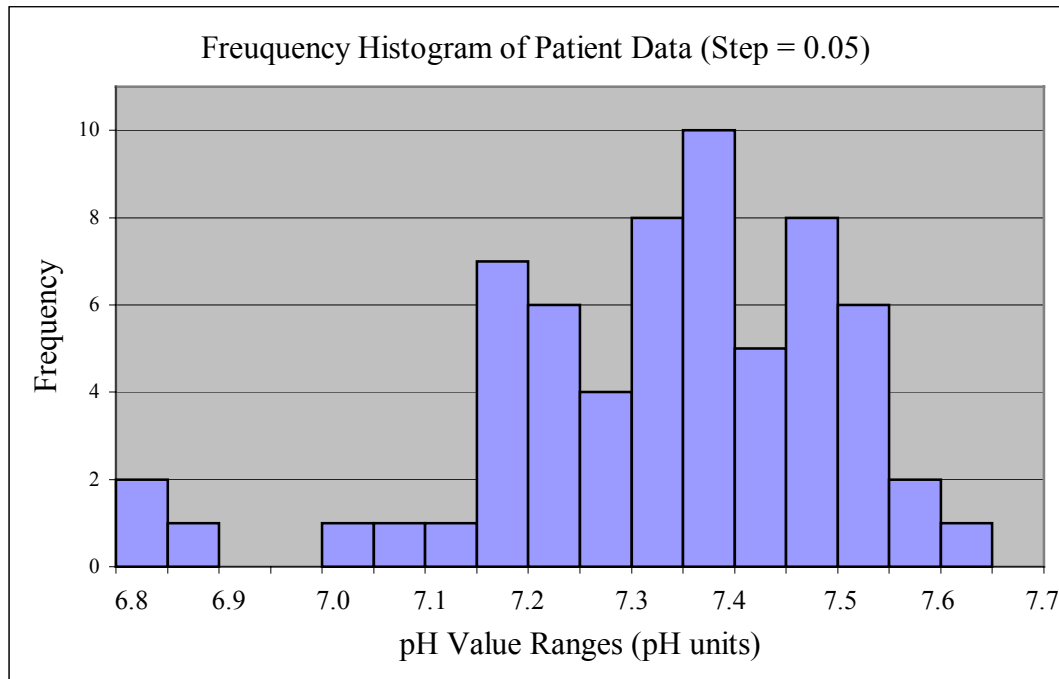




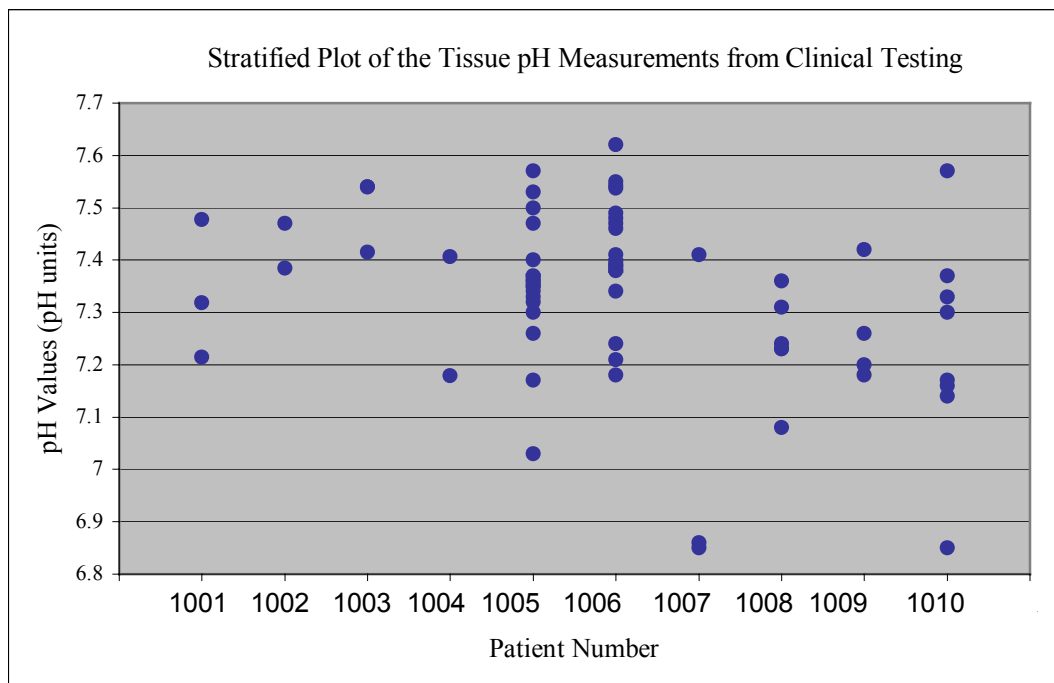
**Figure 7.33: A scatter plot of the cumulative patient data. Sixty-three points from ten patients are plotted.**



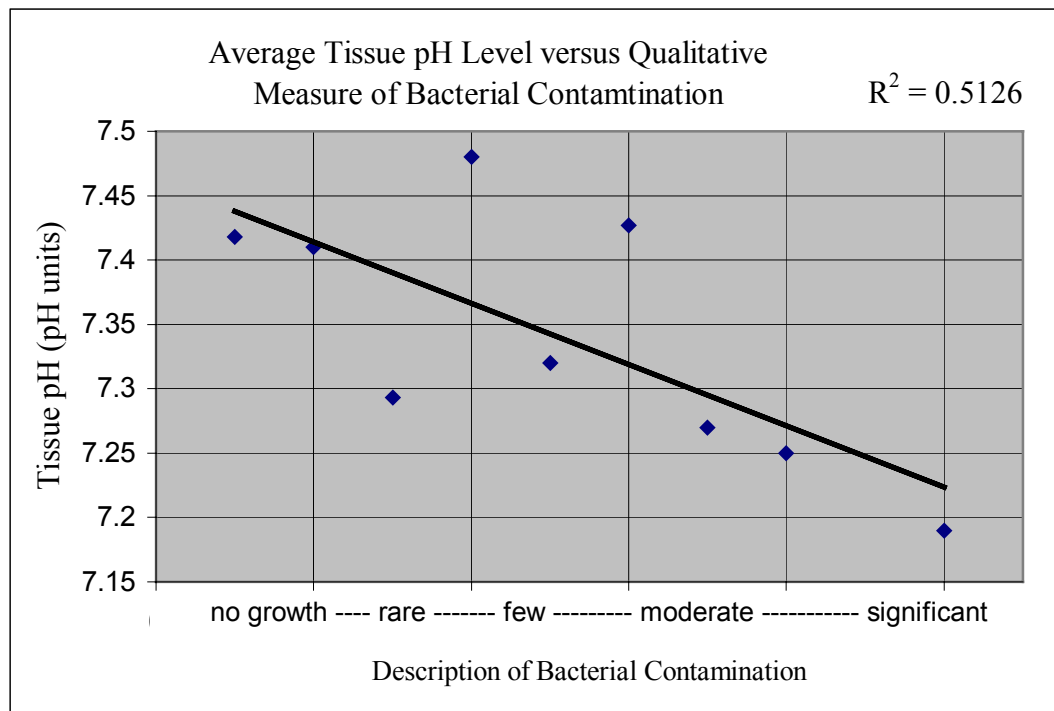
**Figure 7.34: Frequency histogram of the clinical data. The y-axis shows the number of measurements that fall within a given tissue pH range on the x-axis. Measurements from ten patients are represented here.**



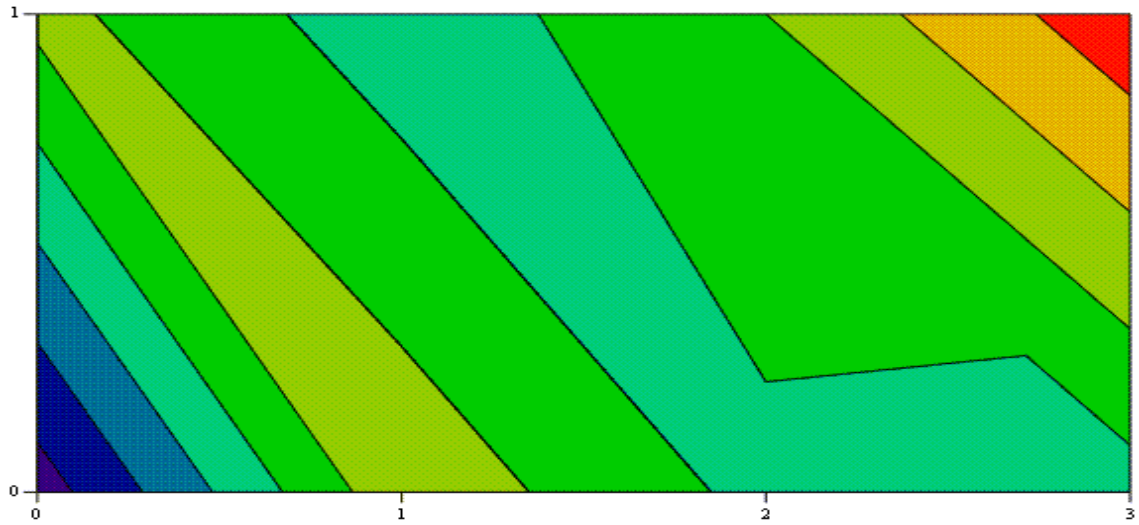
**Figure 7.35: Frequency histogram of patient data with a step size of 0.05 pH units. Measurements from ten patients are represented here.**



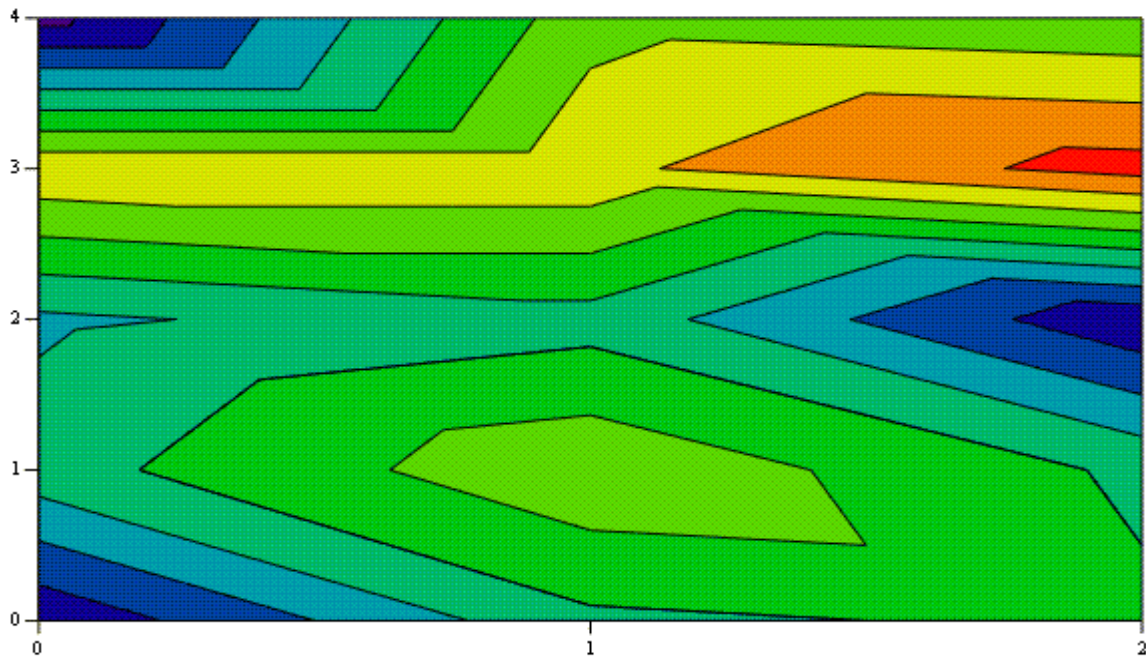
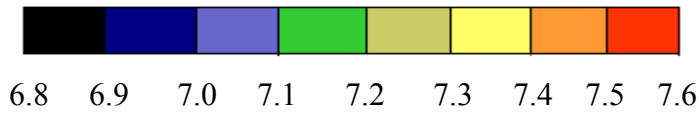
**Figure 7.36: Stratified plot of patient data. The plotted values are the tissue pH measurements acquired from each patient. Data points from a given patient are displayed at one x position.**



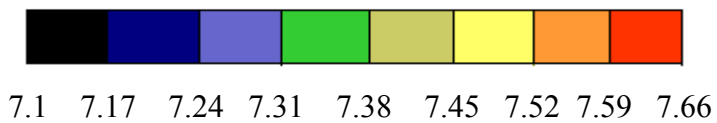
**Figure 7.37: Plot of the average tissue pH level versus qualitative measures of bacterial contamination. Each point represents the average tissue pH level for a different patient. The description of bacterial contamination is determined from qualitative cultures and Dr. Dunn's interpretation of quantitative bacteria counts.**



**Figure 7.38:** Contour plot of the tissue pH variations in patient 1010's wound (Figure 7.34). The plot is oriented as if a rectangle was fit over the patient's wounded area.



**Figure 7.39:** Contour plot of the tissue pH variations in patient 1006's wound (Figure 7.27). The top portion of the graph corresponds to the medial side of the patient's arm and the bottom part corresponds to the lateral side.



## 8. DISCUSSION

The discussion of each of the results presented in the previous chapter will be included here. The results acquired during the testing portion of the research will be analyzed. Comments will be included on what the results indicate in the context of the research goals. Also, any obstacles that were encountered will be noted and explained. This will be helpful for researchers that are interested in conducting similar experiments.

### 8.1 Discussion of Testing of the MI-414 Electrodes

The methods for each of the tests performed on the electrodes were designed so that information could be attained about the operation of the electrodes. Following is a discussion of the results for each of the tests that is described in Chapter 6. The actual results are displayed in the corresponding sections in Chapter 7. Again, it has to be emphasized that the analysis of the results of electrode testing (see Section 7.1) is crucial to the accurate and efficient operation of the pH monitoring system; however, this is not the focus of the research.

#### 8.1.1 Discussion of Time Constant Determination

The purpose of testing the time constants of the electrodes is to design the testing protocol for optimal time efficiency. The results from these tests were incorporated into the software program to reduce the duration of calibration and testing.

##### 8.1.1.1 Discussion of Calibration Time Constant Results

Figure 7.1 displays a graph that shows the stabilization of several electrodes over time. It can be seen from Figure 7.1 that the time needed for the electrodes to stabilize ranges from five to eight minutes. Table 7.1 displays the time needed for stabilization for each of the trials as well as an average time of seven minutes, which will be used as a mark for future calibration procedures. The curves of lesser amplitude in Figure 7.1 represent calibration of electrodes in an 8.0 buffer solution. Additionally, several trials were recorded while calibrating electrodes in a 6.0 pH buffer (the blue curves in Figure 7.1). It can be seen that consistent machine unit levels and times were produced for each trial. The level of the machine units registered for a certain electrode will differ slightly from that of another because of the electrode's specific properties. This means that two different electrodes will produce two different voltage levels when submersed in the same medium. Different electrodes require similar stabilization times, but the level of preconditioning of the electrode will also affect this stabilization time.

If the electrode is allowed to precondition for an extended period of time, the stabilization will occur more quickly. Preconditioning involves placing the electrode in a slightly acidic buffer solution (a 4.0 pH buffer is recommended) for about twelve hours. This will allow the ions to flow across the glass tip of the electrode, resulting in an electrochemical reaction. When the electrode is subsequently placed in a buffer for calibration that is of a more basic pH, the flow of ions will slow down and stabilize. This occurs more quickly than if the flow of ions had to increase to achieve stabilization. Another procedure that helps to shorten the time needed for stabilization is to "exercise" the electrodes between two solutions. This involves dipping the probe into a pH buffer of

4 and then in a buffer of 7 for about five seconds each and repeating this process several times. This helps to activate the ion flow over a range of pH values.

It is extremely important for the electrodes to stabilize during the calibration process. If the voltage that is recorded for a given pH buffer is not the result of a stable reaction between the electrode and solution, the electrode characteristics will be calculated incorrectly. If an electrode's characteristics are inaccurate, pH measurements will not reflect the actual pH level of the medium in question. Therefore, calibration is the basis for all measurements and must be carefully performed. For this reason, the time used for stabilization of the electrodes in the software program is an important parameter.

#### 8.1.1.2 Discussion of Electrode Response Time

The time that it takes for the electrode to respond to a step change in pH is a critical parameter in this research. Previous studies conducted with the developed pH meter involved long term tissue pH measurements [1]. Therefore, the time needed for stabilization of the electrode to the pH level of the tissue was not an issue. In this research, the measurement at a certain location in the wound is terminated as soon as the electrode has stabilized. Because of this, the response time is a limiting factor in the total amount of time needed for testing each subject. In the clinical environment, the time that a test takes effects the patient, the doctor, and the hospital. These are the reasons that this parameter was tested, despite the manufacturer's suggestion that the response time is within fifteen seconds.

The two electrodes that were tested showed similar results, which further confirms the belief that the electrodes are similar in their operation. Figure 7.2 displays curves that exhibit three different components: a flat line which represents the stabilized electrode reading the initial pH buffer, a fall or rise in the pH indicating a change in the electrode position, and a flat line representing the stabilization of the electrode in the final pH buffer. Different combinations of pH buffers were used to determine if there were trends in transitioning between buffers of different pH values.

It was discovered that the pH dropped or rose to close to its final value in a short period of time (approximately five seconds). Subsequently, the electrode experienced a relatively more gradual change to the final value. The last three percent change of the recorded pH to the final value occurred in thirty seconds on average. The average slopes for decreases and increases in pH were calculated and it appears that a rise in pH (from acidic to basic) is measured more quickly than a drop in pH.

From these tests, it can be concluded that for complete stabilization of the electrode in the latter of the two buffer solutions, approximately thirty seconds are needed. This is acceptable for our application. The statistics for each trial can be seen in Table 7.2 and a summary is displayed in Table 7.3. The time and pH at each of the three identified changes in the signal are identified. Using these numbers, the rate of change of the recorded pH can be calculated. The time constant determined in these tests is not used in calibration because during calibration, the electrode is allowed to stabilize for a longer period of time than is actually necessary to ensure absolute stabilization. In addition, the electrode is conditioned after the calibration process, so the optimal time response should be reached by the time testing occurs.

Thus, the electrode will be held at one location in the wound area for at least thirty seconds before moving to the next location. The exact time that is necessary will be determined during preliminary testing, as factors present in the testing environment may affect this stabilization time. The ongoing analysis of the time needed for stabilization will allow for accurate pH measurements as well as time efficiency.

### **8.1.2 Discussion of Stability Tests**

#### **8.1.2.1 Long Term Stability**

The tests done for long term stability show that the drift that occurs over approximately a twelve hour period is 0.088 pH units (see Figure 7.3). This translates into a drift of 0.007 per hour. One electrode is not used for more than an hour during testing; thus, this amount of drift is permissible. The drift is most likely due to the combination electrode configuration. Because this was not a limiting factor in taking point tissue pH measurements, the drift was not explored further.

#### **8.1.2.2 Stability while Holding the Electrodes**

Since the electrodes will be held during the animal and clinical trials, the testing of variations in the recorded pH while holding the electrodes is important. Figure 7.4 shows the result of holding an electrode against a sponge that is saturated with a 7.0 buffer. This method was used to attempt to simulate the conditions that will be found in measuring tissue pH. Contact with the sponge itself most likely lowered the measured pH value.

The most important aspect of the results is that the pH values do not vary more than 0.012 pH units, which is acceptable. The results from holding the probe with the left or right hand could not be differentiated. Thus, holding the electrode to the surface of the tissue should not adversely effect the accuracy of the pH measurements.

### **8.1.3 Discussion of Temperature Dependence Tests**

When measuring tissue pH, temperature levels are normally accounted for. The initial tests showed that pH does vary with changes in temperature but not significantly over small ranges. The recorded change is a result of the pH value of a given pH buffer changing with temperature differences.

The temperature of a wound can vary between 33°C and 41°C, yet the amount of variation in a given wound has not been documented. The pH meter does not make real-time adjustments for temperature differences, so effects of varying temperatures within a wound may increase the inaccuracy of the measurements. It can be seen in Figure 7.5 that over a range of 32 to 40 degrees Celsius, the pH varies a total magnitude of 0.02 pH units. This difference is acceptable in our application. The temperature variations within a single wound should not span the whole range of possible temperatures. Additionally, no data is available on wound temperature variations. We are not incorporating temperature measurements into our methods; thus, we will assume that the wound temperature is uniform throughout.

### **8.1.4 Discussion of Effects of Sterilization**

Table 7.4 displays the change in the calibration characteristics (slope and intercept) after successive sterilizations of one electrode. Both the slope and the intercept change after each sterilization. The first important conclusion that can be drawn from these tests is that ethylene oxide sterilization can be performed on the MI-414 electrodes, and their correct operation is preserved. The second observation is that sterilization changes calibration characteristics; thus, after each sterilization the electrodes must be recalibrated to allow for accurate measurements. Several electrodes were sterilized numerous times, and the same effects were seen.

## **8.2 Calibration of Electrodes**

As can be seen in Figure 7.8, the calibration characteristics of the MI-414 electrodes are expressed by a straight line with negative slope. Two-point calibration is used to determine the slope and intercept of this line. Once calibration has been performed, the characteristics are used to convert a given voltage into a pH value. The issues that are important when calibrating glass microelectrodes are the time needed for calibration and the temperature of the medium that is being measured.

Temperature differences will affect the recorded pH level. Although the difference between room temperature and body temperature is significant, the difference in pH that is produced is not notable because the calibration lines for the electrode at these two temperatures intersects in the range of 6 to 8 pH units (see Figure 7.9). Therefore, insignificant variations in pH will be seen if calibrating at one temperature and measuring at another. For this reason, calibration will be performed at room temperature. This allows for flexibility in the location and times at which calibration can be performed.

Each electrode has specific calibration characteristics, yet the slope and intercept that are calculated using two-point calibration will be similar for all of the electrodes. Table 7.5 shows that these parameters vary within a small region. This fact is important because the electrodes are extremely delicate. If calibration of a given electrode is producing characteristics that deviate greatly from these averages, the electrode should be investigated for improper operation.

## **8.3 Discussion of Animal Study Results**

The results that were presented in section 7.3 will be discussed here. In addition to analyzing the quantitative tissue pH data, the animal models that were used throughout the study will be reviewed.

### **8.3.1 Discussion of Animal Models**

Two major animal models in conjunction with various methods for securing the wound were used through the course of this research (see Section 6.3 for explanation of the methods). Although the animal models did not work as efficiently as expected, improvements were made after each trial, and the best possible protocol was developed using the rat species as the animal of choice.

The first model, which involved making a square inch incision on the lateral, dorsal area of the rat and pipeting bacteria over the rat's tissue, did not work efficiently.



The achieved bacteria levels were not high enough for most of the trials. The highest bacteria levels that were attained in these trials occurred in areas of the tissue that were exposed by the rat chewing at the protective wound covering. When the covering was mutilated, the tissue would become partially necrotic and accurate tissue pH measurements could not be acquired.

Since the levels of bacteria found in the cultured biopsies were significantly lower than the amount of bacteria that was being applied to the wound, a new method for applying the bacteria to the rat's tissue was developed. The second model involved creating the wound on the dorsal, medial area of the rat's body and injecting the bacteria into several areas of the rat's tissue. This would hopefully allow for a better growth of the bacteria in the tissue. The bacteria levels that resulted from this model were higher, on the order of  $10^5$  to  $10^6$ . In addition to a change in the model, the method for securing the wound was altered. The rat's skin was stapled down after inoculating the tissue. This method worked best because the rat was not bothered by the presence of the wound; thus, the tissue was not exposed during the incubation time, and all the tissue pH measurements could be taken without difficulty. The only drawback to stapling the skin is that in some cases, the tissue reattached to the epidermis and the rat's physiological defense mechanisms could better fight the bacteria.

Thus, it was concluded that the best model that could be achieved using the rats in the animal protocol is the following: create a wound on the dorsal, medial area of the rat's body, inject the tissue in several areas with  $2 \times 10^8$  bacteria counts/mL; and secure the wound by stapling the skin edges down. The rat species appears to have high immune response capabilities making it difficult to induce a significant infection. We conclude that the rat is not a good animal to work with when aiming at raising tissue bacteria levels.

### **8.3.2 Recommendation for a New Animal Model**

From the experience of preparing and altering the rat animal protocol, we have several suggestions for the development of a new animal model that may achieve better results. It would be ideal for future animal trials to involve the use of a higher order animal. Several advantages are apparent for choosing a larger animal. One animal can be used for an extensive amount of data. A larger wound can be created, and the animal can be monitored over a longer period of time. The purpose of the animal studies is to create a model that is similar to the circumstances faced in patient wounds. The creation of a wound that is in existence for months as opposed to a few days is more similar to the chronic wounds that are seen in patients. In addition, a higher order animal will have a slower metabolism and will not fight off the applied bacteria as vehemently as the rats did.

Another benefit of using one animal to acquire a large amount of data is that the data can be compared accurately. Although the rat's tissue pH measurements were compared to its healthy tissue pH level, different rats could have different reactions to the creation of the wound and presence of bacteria. By monitoring one animal over a period of time, all of the data can be uniformly compared. A wound that is created in a higher order animal can also be secured better, so as to create an environment that the bacteria

will thrive in best. The drawback of such a model would be the high cost associated with acquiring and maintaining a large animal.

Another option would be the use of mice that are bred to have a deficient inflammatory and immune response making them more susceptible to bacterial infection. This would provide for a more sufficient bacteria growth in the inoculated tissue. Another less expensive option would be to use rabbits which typically have weaker defense mechanisms than the rat species.

The development of a good animal model is important because only at this level can the effects of tissue perfusion and bacterial contamination on tissue pH levels be separated. The animal's tissue is healthy before inoculation; therefore, any decrease in tissue vascularization will be a result of the tissue bacteria levels. This will provide for a more controlled study of the testing parameters. In patient testing, the wound is already composed of compromised tissue and the effect of bacteria levels on tissue pH cannot be isolated. Thus, future work should involve the creation of a new animal model that could produce optimal conditions for the growth of bacteria and the acquisition of tissue pH measurements.

### **8.3.3 Discussion of Cumulative Results**

Looking at Figure 7.14, it can be seen that the tissue pH values vary from approximately 6.8 to 7.5 pH units. The scatter plot shows that taking tissue pH measurements is a stationary process, meaning that the values do not possess a decreasing or increasing trend over the time during which they are acquired. This is expected because the results attained from each trial should be similar, indicating reproducibility of results. This also verifies that the instrumentation and electrodes that are used for testing are in working condition for each trial.

The frequency histogram seen in Figure 7.15 shows that a majority of the tissue pH measurements lie in the range of 7.1 to 7.5 pH units. The most measurements were taken between 7.35 and 7.4 pH units. This is to be expected because normal tissue pH levels lie within and slightly above this range. The histogram is skewed to the left, which makes sense because the measurements taken from infected tissue is expected to have lower tissue pH levels.

### **8.3.4 Discussion of Relationship between Tissue pH and Bacterial Levels**

Due to the difficulties experienced with developing a good animal model, a portion of the data could not be used for analysis of the relationship between tissue pH and bacteria levels. As previously discussed, the first model did not produce results that are usable in this study. Once the second model was developed and the method for securing the wound was finalized, four additional animal trials were performed with a total of 17 rats. This produced a total of eighty-three measurement points.

This data can be seen in Figure 7.16 which displays the differential tissue pH measurement (see Equation 7.2) versus bacteria counts. It can be seen that a trendline with a low  $R^2$  value was fit to the data. Although this indicates that the correlation between the tissue pH and bacteria levels is weak, not enough data has been acquired for this trendline to be considered statistically significant. The data does exhibit a decreasing

trend (increase in bacteria levels correlated with a decrease in tissue pH). Because only seven data points with bacteria levels greater than  $1 \times 10^6$  counts/gram tissue were acquired, it is difficult to statistically analyze the data.

Figure 7.17 shows the data points from the last three animal models. The points that are displayed are those that produced bacteria levels of greater than  $1 \times 10^4$  counts/gram tissue. This is a relevant number because at greater than this level of bacteria, a wound is considered infected. Normal tissue can contain up to  $10^3$  bacteria counts/gram tissue and not be considered infected. The relationship between tissue pH and bacteria levels described by the trendline seen in Figure 7.17 has a  $R^2$  value of 0.57. Again, the lack of data at higher bacteria levels makes it impossible to define a statistically significant relationship between these two parameters.

One of the reasons that the data appears variable is that it is difficult to compare measurement points between rats. Although healthy tissue pH measurements were taken in each rat and differential measurements were calculated, the reaction that each rat has to the presence of bacteria may be different causing varying degrees of tissue pH levels with similar levels of bacteria counts. This would make it difficult to objectively compare data between animals, making a very strong point for acquiring a large amount of data from one animal in the future. In addition, the rat's ability to defend against the bacteria inhibited the growth of the bacteria and the attainment of good results.

Although the data did not reveal a strong relationship between tissue pH levels and bacterial counts, it appears that our hypotheses are correct. Decreased levels of tissue pH are associated with increased levels of bacteria. This becomes more apparent when analyzing data acquired from each rat separately. Because of the difficulties with using the rats in the animal protocol, statistically significant results could not be achieved; yet, we are confident that our data is a starting point for further exploration into the correlation between pH and bacterial levels. The development of a new animal model will better serve this purpose. Section 8.3.2 discusses a possible animal model that could be used in the future.

## 8.4 Discussion of Clinical Study Results

The results that were presented in section 7.4 will be discussed in this section. The clinical testing was successful, although a strong relationship between bacteria and pH levels could not be determined because of the difficulty in acquiring quantitative cultures from each wound. The results will give us a sense of the tissue pH levels that are common in patients with acute and chronic wounds

### 8.4.1 Discussion of Cumulative Results

Figure 7.33 displays a scatter plot which shows that measuring pH of wound tissue is a stationary process. The tissue pH values are reproducible, proving that similar tissue pH levels are found within a wound of one patient and also among patients. This is important because the goal is to determine a technique for utilizing tissue pH as an objective, measurable parameter for all patients. Clinicians need to be able to automatically relate a given tissue pH level with the health of the tissue in question.

The bar plot that can be seen in Figure 7.34 gives a better sense of the spread of the data. This frequency histogram has a single modal bar in the 7.3 to 7.4 pH range,

meaning that a majority of the measurements lie in this range. It drops off more quickly for values less than 7.3 than for values greater than 7.4, but the histogram is somewhat symmetric. The spread of the histogram is small, 1.1 pH units, which indicates that tissue pH measurements from patient wound tissue will fall within a small window. By changing the step size of the x-axis, the data can be considered in a different way. Figure 7.35 shows the bar plot with a pH value step size of 0.05 pH units. This is a short-tailed frequency histogram that is skewed to the left because the central part of the histogram has similar frequencies and it drops off rapidly at the limits and extends further at lower pH levels than at higher ones. The typical range of tissue pH values can be seen to be 7.15 to 7.55 pH units. This is concurrent with medical knowledge. The highest frequency of measurements lies in the 7.35 to 7.4 pH range, indicating that several of the measurements were taken from healthy tissue.

Figure 7.36 shows a stratified plot in which the pH measurements for each of the patients is plotted separately. It can be seen that a majority of the pH values range from 7.2 to 7.6 pH units. Also, the differences in the pH levels between the centers of dispersion for each patient is not large. This is the between variation and is an indication of the reproducibility of the data. Therefore, measuring tissue pH will be consistent within a range for different patients. Also, the spread of the data for a given patient is small, ranging from 0.4 to 0.7 pH units. For example, the measurements taken from patient 1009 range from 7.18 to 7.42, which is a small within variation. The largest within variation is exhibited by patient 1010 (6.85 to 7.57). Within variation is an indication of repeatability. Thus, the low within variation of this data indicates that testing a patient will produce repeatable results within a small range. Note that several of the patients had numerous isolated wounded areas from which tissue pH measurements were acquired. The number of wounds each patient had is indicated in Table 7.8 as well as in the digital photographs displayed in Figures 7.18 through 7.32.

#### **8.4.2 Discussion of Relationship between Tissue pH and Bacterial Levels**

One of the limitations of this research was that quantitative bacterial cultures could not be taken at every point at which tissue pH measurements were performed. Tissue biopsies cannot be taken from outpatients because of the additional trauma that will be caused. Only one tissue biopsy was taken from inpatients because of the lack of medical staff support in the research. In the future, inpatients who are awaiting surgery would be excellent candidates for taking tissue biopsies at several points in the wound. Then, a direct correlation between tissue pH and bacteria levels in human wound tissue could be assessed.

In the current research, a qualitative measure of the wound bacterial contamination was obtained for many cases and a quantitative bacteria count was acquired for a few patients (see Table 7.8). No studies have been performed on the variation of bacteria levels within a wound. Thus, in this study, we will assume that a culture taken from one site in a wound is indicative of the average bacteria level throughout the wound. Because we could not attain a 1:1 ratio of tissue pH measurements to bacteria counts, the tissue pH values for a given wound were averaged so that it could be compared to the relative bacteria level. When the testing was performed, tissue pH measurements were taken in representative locations over the entire area of the wound, i.e. measurements were not only taken in areas that appeared healthy,

for example. Another point to note is that the effects of tissue perfusion and bacterial contamination on tissue pH levels cannot be practically isolated. Therefore, tissue pH levels will reflect the bacteria and perfusion levels.

To better understand the implications of the tissue pH measurements, we will look at a few key patient cases. Patient 1007 suffers from a saphenous vein leg harvest wound. There are three distinct wounded areas (see Figure 7.26 and 7.27). One tissue pH measurement was taken from each of these areas. The wounds displayed in Figure 7.26 have tissue pH levels of 6.85 and 6.86. These wounds are whitish in appearance and contain an abundance of fluid. They have been persistent, non-healing wounds, and a swab culture produced a reading of moderate bacteria levels. Conversely, the wound displayed in Figure 7.27 is mostly reddish in appearance and has a tissue pH level of 7.41, indicating that the tissue is healthy. This is confirmed by the fact that a swab culture from this larger wound resulted in no growth of bacteria. In addition, Dr. Dunn had previously performed a tissue transfer to this area; thus, he expected this wound to be progressing in the healing stages and the tissue to be healthy.

Another excellent case for the comparison of bacteria levels to tissue pH values is patient 1006. The average tissue pH level acquire from this wound is 7.42 and a quantitative culture resulted in a reading of no bacteria growth. Considering that normal tissue pH values range between 7.38 and 7.44 pH units, a pH level of 7.42 should indicate that the tissue is healthy and minimal to no infection is present. The appearance of this wound (see Figure 7.25) may indicate that it is somewhat contaminated. It is important to emphasize that the appearance of wound tissue does not always accurately indicate the level of infection in the tissue. This is a major reason why an objective parameter for estimation of bacterial contamination levels is needed.

Patient 1010's wound exhibits varying levels of tissue pH. The wound can be seen in Figure 7.32. The tissue pH measurements range from 6.85 to 7.57. It can be seen that the measurement that resulted in a tissue pH level of 7.57 is taken from an area of the wound that is whitish. This area was very dry and contained a portion of necrotic tissue which produced a tissue pH value above normal. The location at which tissue pH is measured is of extreme importance in order to acquire accurate results. The remaining points were below normal levels, with an average of 7.19. A quantitative culture was obtained from this patient and resulted in a count of  $2 \times 10^6$  colonies/gram tissue. This qualifies as an infected wound. The low tissue pH level that was calculated corresponds with this high level of bacterial contamination. This case shows that tissue pH is accurate in indicating the health and bacteria level of the wound tissue.

It is also interesting to note that the average tissue pH levels acquired from patients 1008 and 1009 were close in value, 7.24 and 7.27, and the results from the quantitative cultures were the same,  $1 \times 10^4$  colonies/gram tissue. This is promising because the objective is to derive a methodology that can be used for all patients. The standardization of the methods used for acquiring and analyzing the tissue pH data will allow for amore widespread acceptance of this technology.

The graph of the average tissue pH measurements for each patient case versus the qualitative measure of bacterial contamination (see Figure 7.37) shows that there is a correlation between these two variables. The  $R^2$  value of 0.458 indicates that the trendline can predict the data with approximately 46% confidence. Although this is not a

strong linear fit, the trend in the data which exhibits lower pH levels for higher contamination is the relationship that we had hypothesized at the beginning of this research. Performing more clinical tests and acquiring quantitative cultures at each measurement point will produce more relevant data. This will hopefully explain more about the relationship between bacteria and tissue pH levels.

It is important to note that quantitative bacterial counts could not be acquired from the patients. The cultures are very costly to the patient. A quantitative culture costs \$97, and a swab culture costs \$53. Obviously, acquiring several of these cultures from a patient's wound to determine the variation of bacteria levels is not practical because of the high cost. This indicates that a great need exists for the development of a tool to estimate wound bacterial contamination. Measuring tissue pH levels is an excellent solution. In comparison to acquiring tissue cultures, the costs associated with determining tissue pH levels include the purchase of a monitoring instrument, pH electrodes, and pH buffers. The pH electrodes can be sterilized and are therefore reusable.

The ability to monitor a wound's infection level over a period of time using an easily measurable parameter that gives instantaneous results will benefit clinicians and patients. Doctors do not have extensive amounts of time to spend on each patient and often make decisions concerning treatment on judgement alone. They may not have time to analyze the bacteria level that is determined up to forty-eight hours after a culture has been taken, if it is taken at all. An instantaneous measure of a wound's infection will allow for a better understanding of the bacterial contamination at the time of treatment. Thus, there is a great need for further testing of tissue pH as an objective measure of tissue health and the development of instrumentation to efficiently monitor wound pH levels.

#### **8.4.3 Discussion of Tissue pH Variations within the Wound**

As noted previously, the variation of tissue pH values within one wound was not large. The standard deviations for each set of measurements from each patient are displayed in Table 7.8. They range from 0.06 to 0.21 pH units with an average of 0.12 pH units. This small average standard deviation indicates that the tissue pH measurements in each of the wounds tested can be averaged to attain a good sense of the overall pH levels found in the wound.

No previous research was discovered on the variation of tissue pH levels in human chronic wounds. The exploration of tissue pH variation is important because if the tissue pH varied greatly, the use of tissue pH measurements as a measurement parameter would not be objective. Rather, the areas in the wound at which the measurements were taken would dictate the outcome of the testing results.

"pH images" of the tissue pH levels were formed using contour plots. These are seen in Figures 7.38 and 7.39 for two of the patient cases. These plots give a graphical illustration of the tissue pH variations within a wound. It can be seen in Figure 7.38 that the tissue pH is between 7.1 and 7.3 for a majority of the wound. The pH level then drops of to below 7.0 at the left lower corner of image, which corresponds to the left lower corner of the wound seen in Figure 7.32. The pH rises in the upper right corner of

the wound. This indicates that the edges of the wound are not indicative of the average tissue pH level found in the wound.

The image in Figure 7.39 is a plot of the tissue pH variation found in patient 1006's wound (see Figure 7.25). The pH is lower at the medial and lateral, distal edges of the wound as well as towards the elbow of the patient. Higher pH values (7.45 to 7.6 pH units) are found on the medial side of the area that was tested. Again, this indicates that the edges of the wounded area have tissue pH values that vary from those found in the center of the wound.

#### **8.4.4 Indications for Clinicians for Taking Tissue pH Measurements**

The data acquired from patient testing gives some information about the variation of tissue pH levels within a wound and its relationship to bacteria levels. Although this is good scientific information, clinicians need a methodology to utilize this data efficiently in their practices. Information concerning the location, number, and positioning of measurements will be helpful to doctors who are interested in using tissue pH measurements as a diagnostic tool.

From the observations made during testing, the following methodology was developed for accurately and efficiently acquiring tissue pH measurements that are indicative of the wound's tissue pH level. Wound measurement guides are an excellent material to use to guide the clinician as to where to measure tissue pH. The guide that was used in this research to get a sense of the wound's size (see Appendix B) contains boxes of different sizes and a ruler along the edges. The guide should be placed over the wound, and the box that fits the wound best can be selected. The guide used for tissue pH measurements would have small holes at appropriate points throughout the wound area. Thus, if the wound was close to 6 x 6 centimeters, then the electrode would be placed through the holes in that box in the grid to take measurements.

The measurements could then be averaged to calculate an overall tissue pH level for the wound. The person performing the testing must make sure that the tissue pH measurements taken at each point produces a valid value. For example, if one of the measurement points lies over an area of necrotic tissue, that measurement site should be discarded. The number of measurements necessary will vary with the size of the wound. For a 4 x 4 centimeter wound, four measurements will be sufficient. For an 8 x 12 centimeter wound, fifteen measurements would produce an accurate average tissue pH measurement.

There are several advantages and disadvantages of taking tissue pH measurements of wound tissue. The major drawback is that an accurate tissue pH measurement can only be made when enough fluid is present in the tissue. Thus, necrotic tissue or tissue with very low perfusion cannot be measured. Another difficulty is the patient cannot move during testing, and the person performing the measurements must hold the electrode stable for up to a minute. The major advantage of tissue pH measurements is that they are minimally invasive and do not cause any discomfort to the patient. We questioned each of the patients to see if they were in any pain during the testing. Each of the patients responded that they could not feel the electrode during testing. Another good aspect of measuring tissue pH with the micro-combination electrode is that the results are

available at the time of measurement and minimal equipment is needed to acquire the data.

Overall, this technology will be helpful to clinicians in assessing the health of wound tissue and the level of bacterial contamination. Further clinical testing will afford a more concrete relationship between tissue pH and bacteria levels. Once a sufficient amount of testing is performed, a conversion factor between tissue pH and bacteria levels can be calculated. This would allow for clinicians to measure tissue pH, average the results, and then use the conversion factor to estimate the relative level of bacterial contamination in the wound; thus, eliminating the need for acquiring several quantitative cultures. These calculations could be incorporated into a chart of tissue pH versus bacteria levels. The capability of knowing the approximate bacteria level of the wound at the time that the doctor is caring for the patient would allow them to make faster decisions concerning the patient's treatment. This will hopefully lead to a decrease in the length of care that the patient needs and a reduction of cost to all parties involved.



## 9. CLINICAL SIGNIFICANCE

The purpose of this research is to determine the applicability of using tissue pH as an indicator of the health of a tissue. Although the development of an instrument and methods to measure tissue pH in the hospital is a significant scientific contribution, the driving force of the research is the clinician's need for an objective measure of tissue properties. Thus, it is important to look at the clinical significance of the data that has been acquired and seek a doctor's opinion on the information that has been obtained during clinical testing.

Dr. Dunn, an experienced plastic surgeon, was questioned on the potential uses and acceptance of tissue pH measurements in medical practice. He is an experienced plastic surgeon and has worked with many residents and veteran doctors. Thus, he has a very good sense of clinicians' views on measurement parameters, such as tissue pH, that can be used as helpful tools in their work. The answers to the following questions provide insight into the acceptance that tissue pH, as a measurement tool, will have in the clinical environment.

**Researcher:** What significance do pH levels have to clinicians? For example, if you were to tell a doctor a tissue had a pH level of 7.0 versus 7.4, how would they analyze this information or what would it indicate to them?

**Dr. Dunn:** At this point, clinicians do not have a good understanding of what tissue pH levels indicate. They are more familiar with physiologic (or blood) pH, which has the same normal level as tissue pH of 7.4 pH units. Tissue pH measurements are not usually taken in the hospital because of lack of appropriate technology and methodology.

**Researcher:** Would medical personnel be open to the idea of incorporating tissue pH measurements into their "normal" regiment of treating patients with chronic wounds?

**Dr. Dunn:** Definitely, the tissue pH measurements are noninvasive, easy to take, safe to the patient, and provide instantaneous results. It would give the doctor an instant indication of the health of the tissue without waiting for lab results.

**Researcher:** How would the knowledge of tissue pH levels of a chronic wound benefit the patient and the doctor in the diagnosis of a wound's status?

**Dr. Dunn:** The knowledge of a wound's tissue pH levels would be very beneficial. If the pH is normal, then the surgeon will know that the tissue is relatively healthy, and he/she can proceed with surgical closure of the wound. If the pH is low, the surgeon will know that the tissue is unhealthy. In this case, intervention will be needed prior to grafting.

**Researcher:** In your opinion, how big of a contribution would the development of a user-friendly device that instantaneously measures tissue pH be to the plastic surgery field?

**Dr. Dunn:** The development of such technology would be extremely valuable for all the reasons previously discussed. It would enable doctors to easily and

instantaneously determine tissue pH levels, which gives us important information about the tissue's health.

**Researcher:** Would the availability of such a tool possibly decrease the length of time needed for patient treatment? How?

**Dr. Dunn:** Access to tissue pH information would shorten the time a patient needs treatment and therefore decrease costs to the patient and the hospital. An instantaneous indication of the health of a tissue will allow for a more timely determination of treatment/surgery.

**Researcher:** Where else in medical practice would such technology be useful?

**Dr. Dunn:** This technology would be used to monitor tissue pH flaps in microvascular surgery. In other areas of medicine, the first thing that comes to my mind is cardiac surgery, where myocardial tissue pH measurements are of great value.

**Researcher:** Provide any other comments on the use of tissue pH levels in plastic surgery.

**Dr. Dunn:** Because clinicians are not familiar with using tissue pH levels as an indicator of a tissue's health, a methodology must be developed to tell them how to use this information in diagnosis of acute and chronic wounds. Where in the wound is it most appropriate to measure? Should you measure in areas that "look" the worst? Should you make a single measurement or several and calculate an average? Once our hypotheses about tissue pH as an indication of bacterial contamination and tissue health have been proven, a conversion must be provided by which doctors will be able to measure a wound's pH, and automatically know what the pH values indicate.

## 9.1 Medical Staff Reaction

The medical staff reaction is extremely important when introducing new technology into the hospital. Even the most sophisticated instrumentation will not be accepted by the hospital staff if they cannot easily and efficiently operate it. When I performed the tissue pH measurements in the hospital, I achieved a sense of how nurses, physician assistants, and doctors perceived the work that we were performing. Medical personnel understand how difficult it is to care for patients with chronic wounds. Because of this, they were very intrigued by the possibility of being able to have a real-time measure of the wound's tissue characteristics. Several of the nurses asked me to explain the theory behind our research. They were familiar with tissue pH levels and were delighted to see work being done in this area.

From my experience in performing these tests, it appears that the practice of measuring tissue pH levels in the hospital will be accepted if the medical staff is provided with a technology that is easy to use and can be efficiently incorporated into current medical practices. The advantages of performing tissue pH measurements are that they can be performed fairly quickly and are not costly in comparison to acquiring bacteria counts through tissue cultures, which ranges from \$53 to \$97 per culture. Once further

supporting evidence on the applicability of using tissue pH measurements as an indicator of bacteria contamination is achieved, tissue pH technology should be readily accepted into medical practice.

## 9.2 Future Applications

The development of technology to accurately and efficiently measure tissue pH levels in chronic and acute wounds has widespread applications. The most obvious is in assessment of in and outpatients seeking care of wounds that are caused by disease, infection, or trauma. The knowledge of tissue pH levels will give the doctor an indication of the health of the tissue, including level of vascularization and bacterial contamination. Measuring tissue pH of flaps that have been transferred during microvascular surgery is also important. The success of a graft depends on the patency of the blood vessels in the tissue. A drop in tissue pH will indicate loss of this patency (the onset of ischemia). By monitoring tissue pH, the problems that caused the tissue to become ischemic can be resolved before further surgery is necessary.

Tissue pH measurements are also of great interest to cardiologists. The tissue pH level of myocardial tissue can indicate the health of the tissue and whether areas of the tissue are experiencing degrees of ischemia. Basically, any medical field that deals with the tissue of the body and determination of its health will benefit from the technology and knowledge of measuring and analyzing tissue pH.

Patients that see multiple doctors in the hospital would benefit from having their tissue pH levels documented in the hospital's central network. The doctor can then look up the patient's previous wound tissue pH measurements, for instance, and compare them to the current pH level of the tissue. This will indicate whether the tissue has become less or more healthy. Comparison of tissue pH measurements is also a good practice because the "normal" pH level of each patient may differ slightly.

In the future, another application of instantaneous tissue pH measurements will be in remote medical practice. Nurses can take tissue pH measurements of a patient's wound and send this information to the surgeon who is off-site. He will be able to analyze this information objectively and have a better sense of the health of the tissue. In this way, he will be able to provide better advice to the medical staff on hand in the diagnosis and treatment of the patient in question. Obviously, the incorporation of tissue pH measurements into the medical field could have widespread effects. Thus, further research in this area is substantiated and important.

## 10. CONCLUSIONS

The main objective of this research was to conduct an exploration of tissue pH measurements in human wounds and determine if a correlation exists between tissue pH levels and bacterial contamination. The determination of a pattern in the variation of tissue pH levels throughout a wound was another research objective. The development of a methodology for clinicians to use in their assessment of wounds were the final goal of this research. This will allow for the scientific facts that are discovered throughout the research to be applied to the medical field.

### 10.1 Achievement of Aims

In this section, each specific aim stated in Chapter 2 will be reviewed to determine whether or not it was achieved. If an aim was achieved through the course of the research, the major findings will be dictated and the section of the text that further explains the results will be referred to. If the aim was not achieved, future work that needs to be done in that area will be discussed.

- Analyze current problems and define research specifications.

The problems that provoked this research were carefully reviewed, and research specifications were defined. A thorough investigation of past research in this area was performed, and the achievements in this field were incorporated into the chapter on background information (see Chapter 4).

- Test the MI-414 electrodes, which will be used for measuring tissue pH.

This aim was achieved during the beginning stages of the research to ensure that the electrodes worked efficiently and properly with the pH monitoring system. See sections 6.1, 7.1, and 8.1 to learn more about the methods and results of these tests.

- Design a software program to acquire and process tissue pH data and perform bench tests on the pH monitoring system.

The next step in the research was to design a software program that was compatible with the monitoring system that was developed by Gumbrell [4]. The program, which was developed in LabWindows, controls the actions of the hardware. It performs calibration of the electrodes and continuous and point-by-point monitoring of tissue pH. The program contains algorithms that process the raw tissue pH data and calculate appropriate averages for point measurements. The monitoring system, software program, and electrodes were tested together to ensure that the entire system worked correctly. See Chapter 5 on the description of the hardware and software for more details on the pH monitoring system.

- Develop an animal protocol and perform animal studies.

Once the instrument was performing the desired functions, an animal protocol was developed and tested. The animal model was a major limiting factor in the achievement of the research goals. Although four different models were developed (see section 6.2), none consistently produced high bacteria levels in the rat's tissue. The acquired tissue pH measurements were accurate, and the animal trials were helpful in refining the acquisition process; the rat's physiological defense mechanisms were too strong for sufficient bacteria growth to result. Thus, a definitive correlation between tissue pH and

bacteria levels could not be defined; a decreasing linear trend of tissue pH versus bacteria levels is noticeable, but more measurement points are needed for the data to be conclusive. Future animal studies need to be performed to determine the exact relationship between tissue pH and bacterial contamination. We suggest that a higher order animal species be used. A large wound area could be created and inoculated. Then, the animal could be monitored over time, while taking tissue pH measurements and biopsies. It would be helpful to develop a protective material that produces an environment in which bacteria can thrive. It was difficult to secure the wounds created in the rats because they were easily aggravated by the presence of foreign materials on their body. Overall, we concluded that rats do not serve the purpose of this study well.

- Perform clinical testing.

Clinical testing was then performed to determine typical variations in patient wound tissue pH levels. A sterilization protocol was developed to ensure that the electrodes that came into contact with the patients were completely sterile. Qualitative bacteria levels were acquired from each wound and compared to the average tissue pH level (see section 7.4 and 8.4). Digital photographs of each wound were taken and the locations in the wound that were measured were labeled. All of this information is helpful in analyzing the tissue pH levels in relation to the wound tissue's properties.

- Develop a methodology for estimating a chronic wound's properties.

The final aim was achieved using the information obtained from clinical testing (see section 8.4). A suggested methodology for acquiring tissue pH measurements from a patient's wound was described (see section 8.4.4). The number of measurements needed to get an accurate sense of the average tissue pH level of the wound's tissue is dependent upon the size of the wound. From the research's findings, it is apparent that the pH levels of the tissue towards the center of the wound are more indicative of the overall wound tissue pH. Thus, a guide could be developed that will indicate to the clinician where to take the pH measurements. Because the variation of tissue pH measurements within the wound was small, an average of these measurements is a good indication of the wound's tissue pH level.

Although a quantitative relationship between tissue pH and bacteria counts was not determined, it is apparent that tissue pH is a good indication of the overall health of the tissue. The chapter on suggested future work (Chapter 11) will address the issues that still need to be resolved in order to develop a clear methodology for using tissue pH as an indication of bacteria levels in wounds.

## 10.2 Conclusions on Hypotheses

Several hypotheses were formed at the beginning of this research effort. It is important to address each of the hypotheses separately to determine their validity and explain the reasoning, if necessary, for why the hypothesis was proven wrong or has yet to be proven.

*The first main hypothesis* was that tissue pH can be accurately measured in chronic wounds.

Using the developed pH monitor and MI-414 pH electrodes, the tissue pH of wound tissue was accurately measured. As long as the electrode tip was in contact with a small amount of fluid, a proper junction would result and the tissue pH could be acquired within forty-five seconds. The person performing the testing must ensure that the electrode is not moved while taking measurements because this will affect the acquired data. Only a small amount of pressure on the tissue is needed and causes no discomfort to the patient. Thus, tissue pH can accurately be measured in patient wounds. See the Results chapter for the tissue pH levels that were collected and section 5.4.2 for how the final average was calculated from the approximately minute long pH signals.

*The second main hypothesis* was that a relationship between tissue pH and the level of bacteria in wounds exists.

From the testing done during this research, we cannot conclude that tissue pH and bacteria levels have a quantitative relationship. Due to obstacles in developing an efficient animal model and in acquiring quantitative bacterial data from patients, a definitive relationship between tissue pH and bacteria levels could not be determined; yet, it is apparent that a relationship exists between these two parameters. The data shows a decreasing trend in tissue pH measurements as bacteria levels increase (see Figure 7.16). This relationship was expected due to the physiological mechanisms of bacteria and how they affect the health of tissue.

Ten patients were tested during the course of the clinical study. Only qualitative information about the bacteria levels could be attained for a majority of the patients; thus, the determined relationship between tissue pH and bacteria levels is not definitive (see Figure 7.39). In addition, tissue pH levels were compared among patients on the premise that normal tissue pH levels are similar for each patient. The general trend that was found is that as the bacteria level increases, the average tissue pH level decreases. This relationship was expected. Future studies need to be done to ascertain a quantitative relationship between tissue pH and bacteria levels.

*The third main hypothesis* was that wound bacteria levels vary at different points in the tissue.

Ten patients were tested; a varying amount of tissue pH measurements were taken from each individual, depending on the size of the wound and time limitations. We were not able to acquire quantitative cultures for more than one point in each wound; thus, variations in bacterial contamination could not be determined. On the other hand, variations of tissue pH were found in each wound within a given margin. The average of all the patient tissue pH data was 7.33 pH units and the standard deviation was 0.17 pH units. Thus, on average, the pH measurements varied within a range of 0.17 pH units above and below 7.33. Looking at each patient separately, it can be seen that the tissue pH variations ranged from 0.4 to 0.7 pH units. It should be noted that the amount of variation in any given wound was not dependent on the number of measurements that were taken from that patient. It was more dependent on the differences in the health of the tissue and the locations at which the measurements were taken. Due to this relatively small variation, if a sufficient number of measurements are taken from a patient's wound,

then an average of these points will give a good indication of the overall tissue pH level and the health of the tissue.

*The fourth main hypothesis* was that it is possible to estimate tissue pH levels by interpolation from known data points.

Once the clinical testing was begun, it was established that the number of measurements that could be taken was not nearly enough to implement interpolation algorithms to achieve an overall picture of the tissue pH levels throughout the wound. As stated earlier, the tissue pH variations within the wound are not drastic; thus, an average of the measurement points gives a good indication of the overall tissue pH level. If the wound is extensive, then it may be beneficial to take measurements from several areas and calculate pH averages for different portions of the wound. This would be helpful because surgeons often only graft the parts of larger wounds that are ready for surgical closure. Thus, after clinical testing was performed, it was concluded that interpolation of tissue pH data points would not be helpful to the clinician.

*The fifth main hypothesis* was that given a correlation between tissue pH and bacterial contamination of a chronic wound, it is possible to develop an efficient methodology to help clinicians use this scientific information.

Although a definitive correlation between tissue pH and bacterial contamination was not determined, a relationship does exist between tissue pH and bacterial contamination. From the patient testing results, we conclude that it is possible to develop a methodology that will efficiently determine an average tissue pH level of a patient's wound and indicate the level of health of the wound tissue. Section 8.4.4 on *Indications for Clinicians for Taking Tissue pH Measurements* explains what this methodology would entail. Clinicians can measure tissue pH at specified points in the wound, depending on the wound size, and get a sense of the health of the tissue depending on how far the average tissue pH level falls from the normal value of 7.4 pH units. This will provide doctors with an excellent tool for objectively determining the health of wound tissue. If a quantitative relationship is determined in the future, this would make the process of translating tissue pH values into the level of bacterial contamination even more objective.

Overall, some of the hypotheses were proven correct while more research needs to be performed to confirm that the remaining hypotheses are true without a doubt. The data that was acquired during this research is preliminary but is an excellent starting point for research on the use of tissue pH measurements in diagnostic medicine. Although pH is a common scientific parameter, it has not been used extensively in the hospital to date. It can provide a real-time and objective measure of the health of wound tissue and can be used as an indicator of the bacterial contamination present in that tissue. This information can in turn be used to determine appropriate treatment so that a wound can progress towards faster healing or become healthy enough to allow for surgical closure. In both cases, a decrease in the amount of time that a patient needs care will decrease the cost associated with the wound treatment and will benefit all parties involved. Our hope

is that the practice of measuring tissue pH becomes widely used in the medical field in the future.



## 11. FUTURE WORK

Although this research addressed many issues, each of which is presented at the beginning of this research in the problem identification chapter, several more issues must be addressed in the future. This will enable the further development of the concepts that were introduced. Once this research was begun, it was realized that the information collected could only represent preliminary work in this field. Very few investigators have looked at the applicability of tissue pH levels in wounds as a measure of the wound's healing rate and bacterial contamination.

This work has provided original work by looking at the variation of tissue pH levels throughout wounds first in created wounds in rats, and second in patients with chronic or acute wounds. It has dealt with the possible relationship that tissue pH has with infection rate and a clinician's opinion of the wound's status. The areas that still must be explored further are instrument development, animal protocol development, clinical testing and applicability, electrode selection, calibration techniques, remote accessibility, and collection of more data. These points will now be discussed.

### **Instrument Development:**

The instrument that was utilized for this research is large and heavy, limiting its use. Future generations of the instrumentation should aim at minimizing the size of the instrument. Ideally, the tissue pH monitor will be a handheld device that a clinician could easily carry in his/her pocket. The instrument would contain all the hardware necessary to read a tissue pH signal from a micro-combination electrode. It would possess an LED display that would show the changing pH levels, in real-time, of the medium with which the electrode is in contact.

The instrument would also be capable of calibrating the electrode quickly and efficiently prior to testing. This will be addressed during the discussion of the calibration technique. The development of a small, lightweight instrument would allow for this technology to be easily accepted by clinicians. Once it has been established that tissue pH is an indicator of several properties of chronic and acute wounds, the presentation of a user-friendly instrument will allow for an easy introduction of the methodology of this research into everyday medical practice.

### **Animal Protocol Development:**

During this research the best animal protocol using rats was developed; however, we concluded that rats are not a good species to work with when attempting to increase tissue bacteria levels. Therefore, future work should involve the development of a better animal model. Section 8.3.2 explains several of the criteria that should be incorporated into this model. The goal is to be able to inoculate the animal's tissue and measure bacteria levels ranging from  $10^2$  to  $10^8$  bacteria counts/gram tissue. This will allow for the achievement of a good distribution of bacteria levels and the corresponding tissue pH values. It is vital to develop a good animal model because of the difficulty in isolating the effects of tissue perfusion and bacterial contamination on tissue pH levels in human wounds. The animal model will provide scientific data that is crucial for the acceptance of tissue pH measurements as an objective, diagnostic tool of wound tissue.

### **Clinical Testing and Applicability:**

Further clinical testing needs to be performed to ascertain the applicability of the proposed technology in the clinical environment. An extensive clinical study must be launched to determine whether the notion of tissue pH levels as an indicator of bacteria levels and healing rates of wounds can hold for all types of clinical wounds. The techniques used for preparing the electrodes, i.e. conditioning and calibration, and acquiring the data must be refined. Doctors and nurses should be more involved in the study to achieve an understanding of their reaction to the idea of incorporating tissue pH measurements into their current routine of diagnosis and treatment.

### **Electrode Selection:**

The glass pH micro-combination electrodes used during this research were selected because they could accurately measure tissue pH in a reasonably small amount of time on the tissue surface of wounds. Thus, the selection of the most appropriate electrode for this application was not an aim of this research. To make the instrument/electrode combination the most accurate and efficient unit possible, future work should involve the assessment of all the pH electrode technology that is available on the market. If financial cost is not an issue, several electrodes that use different technology should be tested.

The optimal criteria that should be met are as follows: 1) minimal response time; 2) durability and stability; 3) good drift characteristics; 4) ability to gas sterilize; 5) minimal invasiveness; 6) ease of use; and, 7) applicability in tissue measurements. Most importantly, the electrode should be minimally invasive with a fast response time to a stable pH level. Although the MI-414 electrodes were minimally invasive, their response time was longer than is desirable and their stability was insufficient. The selection of an electrode that meets these criteria would allow for the improvement of the ease of using the monitoring system. It would also provide for more accuracy and less of a need for offline analysis of the tissue pH data.

### **Calibration Techniques:**

As discussed in this thesis, the calibration of the electrodes is both necessary and difficult. There are several factors that must be addressed including the time and frequency of calibration. Ideally, calibration would be performed immediately prior to testing and could be done with ease by the nursing staff. If a hand-held device for pH monitoring is developed, switches could be incorporated into the hardware. A two-point calibration could then be done by reading the voltage level of each of two known pH buffers and adjusting the pH level that the electrode reads to that of the known value using. This would automatically calibrate the electrode. The instrument would calculate the calibration characteristics and store them in memory. Enough memory should be incorporated into the hardware to save several electrode calibration characteristics. The calibration techniques need to be reevaluated for every instrument generation that is developed. The goal is to minimize the time and steps needed to accurately calibrate the electrodes.

### **Remote Accessibility:**

The information that is recorded on the pH monitor should be available for downloading on the hospital's central network system. Many hospitals do not possess a

modern network, but most have some form of networking for patient records; and in the future, these networks will be updated, as technology becomes available and less costly. The easiest way for the tissue pH data to be available would be to incorporate a modem into the instrument design. The monitor should record several sets of data, from different patients. Medical personnel could subsequently download this information into the hospital network so that every doctor that comes into contact with a given patient can view his/her tissue pH levels and also compare previous tissue pH to current ones. This would give the doctor an indication of the progression (positive or negative) of the wound. Another way to download the tissue pH information would be by telemetry, yet this technology is in relatively early stages of development. At any rate, the information acquired from the instrument will be more helpful if it can be made available on the hospital networking system.

Each of these issues should be addressed in future research. If each of these aims is achieved, the pH monitoring technology and knowledge that will result will aid in revolutionizing the way in which clinicians diagnose and treat patients with chronic and acute wounds. It will aid in the expedience with which patients are treated and healed. This will translate into a reduction of financial costs for the patient, hospital, and society as well as a decrease in the emotional trauma that patients may experience due to a chronic disability or elongated hospital delay. Thus, the future progression of this research should be a priority to doctors, engineers, and scientists who would like to further the technology and knowledge of the applicability of tissue pH in the medical field.

## 12. BIBLIOGRAPHY

1. Ye RC, "The Relationship of pH of the Granulation Tissue and the Take of the Skin Graft", *Plastic & Reconstructive Surgery*, Vol. 19, no. 3, pp. 213-217, 1957.
2. Kaufman T, Hirshowitz B, "The influence of various microclimate conditions on the burn wound: a review", *Burns*, Vol. 9, pp. 84-88, 1978.
3. Dickson MG, Sharpe DT, "Continuous subcutaneous tissue pH measurement as a monitor of blood flow in skin flaps: an experimental study", *British Journal of Plastic Surgery*, Vol. 38, pp. 39-42, 1985.
4. Gumbrell GP, Peura RA, Kun S, Dunn RM, "Evaluation of a Minimally Invasive pH Based Microvascular Ischemia Monitor", *Journal of Clinical Engineering*, Vol. 23, no. 5, pp. 344-353, 1998.
5. Dunn RM, Kaplan IB, Mancoll J, "Experimental and clinical use of direct pH monitoring of free tissue transfer", *Annals of Plastic Surgery*, Vol. 31, pp. 539-545, 1993.
6. Harrison DK, Walker WF, "Micro-electrode Measurement of Skin pH in Humans During Ischaemia, Hypoxia and Local Hypothermia", *Journal of Physiology*, Vol. 291, pp. 339-350, 1979.
7. Wolpert PW, Noller K, Shaughnessy D, Houchin DN, Baccari ME, Miller FA, "Tissue pH: A New Clinical Tool", *Archives of Surgery*, Vol. 101, pp. 300-313, 1970.
8. Edlich RF, "Studies in Management of the Contaminated Wound", *The American Journal of Surgery*, Vol. 118, pp. 21-30, 1969.
9. Edlich RF, "Studies in Management of the Contaminated Wound", *The American Journal of Surgery*, Vol. 117, pp. 322-328, 1969.
10. Robson MC, Heggors JP, "Bacterial Quantification of Open Wounds", *Military Medicine*, pp. 19-24, 1969.
11. Sanderson MC, Bentley G. "Assessment of Wound Contamination during Surgery: a Preliminary Report comparing Vertical Laminar Flow and Conventional Theatre Systems", *British Journal of Surgery*, Vol. 63, pp. 431-432, 1976.
12. Schneider M, Vildozola CW, Brooks S, "Quantitative Assessment of Bacterial Invasion of Chronic Ulcers", *The American Journal of Surgery*, Vol. 145, pp. 260-262, 1983.
13. Georgiade GS, "Wound Contamination, Assessment, Prevention, and Management,

Postgraduate Medicine, Vol. 73, no. 3, pp. 247-253, 1983.

14. Robson MC, Krizek TJ, "Predicting Skin Graft Survival", The Journal of Trauma, Vol. 13, no. 3, pp. 213-224, 1973.
15. Iaizzo PA, Kokate J, Seiffert D, Leland K, Hansen G, Sparrow E, Chinchoy E, "Wound Formation, Treatment, and Healing", Departments of Anesthesiology and Neurology, University of Minnesota, Minneapolis, MN, [http://www1.umn.edu/anesthes/research/wound\\_form.html](http://www1.umn.edu/anesthes/research/wound_form.html).
16. Berriss B, Sangwine SJ, "Automatic Quantitative Analysis of Healing Skin Wounds using Colour Digital Image Processing", <http://www.smtl.co.uk/World-Wide-Wounds/1997/july/Berriss/Berriss.html>, 1997.
17. Wilson APR, Weavill C, Burrige J, Kelsey MC, "The use of the wound scoring method 'ASEPSIS' in postoperative wound surveillance", Journal of Hospital Infection, Vol. 16, pp. 297-309, 1990.
18. Rudolph R, Noe JM, Chronic Problem Wounds. Boston: Little, Brown, and Company, 1983.
19. Nwomeh BC, "Physiology of the Chronic Wound", Clinics in Plastic Surgery, Vol. 25, no. 3:, pp. 341-354, 1998.
20. Steglitz der Freien K, "Electrochemical Aspects of pH Electrodes", Digestive Diseases, Vol. 8, pp. 18-22., 1990.
21. Bates RG, Determination of pH, Theory and Practice. New York: John Wiley & Sons, Inc., 1964.
22. Matsumura Y, Satake N, Fujimoto M, "Physicochemical Characteristics of Antimony Microelectrode with Special Reference to Selection of Standard Buffers", Japanese Journal of Physiology, Vol. 30, pp. 509-528, 1980.
23. Das JB, Joshi ID, Philippart AI, "Continuous Monitoring of pH in the Tissue Mode: Evaluation of Miniature Sensor During Acidosis and Tissue Hyperfusion", Journal of Pediatric Surgery, Vol. 18, no. 6, pp. 914-920, 1998.
24. Shorrock SM, Kun S, Peura RA, Dunn RM "Development of a Minimally Invasive pH Monitor: Noise and Artifact Analysis", Submitted for Publication, Journal of Clinical Engineering, 2000.
25. Steglitz der Freien, K, "Graphical Display and Statistical Evaluation of Data Gained by Long-Term Ambulatory Intra-gastric pH Monitoring", Digestive Diseases, Vol. 8, pp. 82-86, 1990.

26. Rohmel J, Merki HS, Wilder-Smith CH, Walt RP, "Analysis and Statistical Evaluation of Continuous pH Recordings", *Digestive Diseases*, Vol. 8, pp. 87-96, 1990.
27. Klein DG, Fritsch DE, Amin SG, "Wound Infection Following Trauma and Burn Injuries", *Infection and Control in Critical Care*, Vol. 7, no. 4, pp. 627-640, 1995.
28. Ramasastry SS, "Chronic Problem Wounds", *Clinics in Plastic Surgery*, Vol. 25, no. 3, pp. 367-394, 1998.
29. Robson MC, "Wound Infection: A Failure of Wound Healing Caused by an Imbalance of Bacteria", *Surgical Clinics of North America*, Vol. 77, no. 3, pp. 637-650, 1997.
30. Whyte W, Hambraeus A, Laurell G, Hoborn J, "The relative importance of the routes and sources of wound contamination during general surgery", *Journal of Hospital Infection*, Vol. 22, pp. 41-54, 1992.
31. Davidson AIG, Clark C, Smith G, "Postoperative Wound Infection: a Computer Analysis", *British Journal of Surgery*, Vol. 58, no. 5. pp. 333-337, 1971.
32. Levine NS, Lindberg RB, Mason AD, Pruitt BA, "The Quantitative Swab Culture and Smear: A Quick, Simple Method for Determining the Number of Viable Aerobic Bacteria on Open Wounds", *The Journal of Trauma*, Vol. 16, no. 2, pp. 89 –95, 1976.
33. Magee C, Haury B, Rodeheaver G, Fox J, Edgerton MT, Edlich RF, "Rapid Technic for Quantitating Wound Bacterial Count", *The American Journal of Surgery*, Vol. 133, pp. 760-762, 1977.
34. Heggors JP, Robson MC, Doran ET, "Quantitative Assessment of Bacterial Contamination of Open Wounds by a Slide Technique", *Transactions of the Royal Society of Tropical Medicine and Hygiene*, Vol. 63, no. 4, pp. 532-534, 1969.
35. Trott AT, Wounds and Lacerations, Emergency Care and Closure. Boston: Mosby, 1991.
36. Hunt TK, "Respiratory Gas Tensions and pH in Healing Wounds", *American Journal of Surgery*, Vol. 114, pp. 302-306, 1967.
37. Lim RC, "Metabolic and Blood Flow Changes in Healing Wounds: A Measurement of Microcirculatory Development", 5<sup>th</sup> European Conference Microcirculation, Gothenburg, no. 10, pp. 328-333, 1968.
38. Lengheden A, Jansson L, "pH effects on experimental wound healing of human

- fibroblasts”, *European Journal of Oral Science*, Vol. 103, pp. 148-155, 1995.
39. Mulder GD, “If Wounds Could Talk”, *Clinical and Experimental Approaches to Dermal and Epidermal Repair: Normal and Chronic Wounds*, pp. 55-66, 1991.
40. Gumbrell GP, “Development of a pH Tissue Ischemia Monitor”, M.S. Thesis, Worcester Polytechnic Institute Library, Worcester, MA, 1997.
41. Saymen EG, Nathan P, Holder IA, Hill EO, Macmillan BG, “Infected Surface Wound: an Experimental Model and a Method for the Quantitation of Bacteria in Infected Tissues”, *Applied Microbiology*, Vol. 23, no. 3, pp. 509-514, 1972.
42. Chen C, Schultz GS, Bloch M, Edwards PD, Tebes S, Mast BA, “Molecular and mechanistic validation of delayed healing rat wounds as a model for human chronic wounds”, *Wound Repair and Regeneration*, Vol. 7, no. 6, pp. 486-494, 1999.

## APPENDIX A

HSC Docket # H- 9859

UNIVERSITY OF MASSACHUSETTS MEDICAL SCHOOL  
 COMMITTEE FOR THE PROTECTION OF HUMAN SUBJECTS IN RESEARCH  
 UMass/Memorial Health Care

## CONSENT TO PARTICIPATE IN A RESEARCH PROJECT

Title: Estimation of Wound Properties by pH Measurement

Principal Investigator: Raymond Dunn, M.D.

Date:

Sponsor:

Research Subject's Name: \_\_\_\_\_ Date:

**Invitation To Take Part and Introduction**

You are invited to volunteer for a research study. You are asked to take part because you have a chronic wound.

**Purpose of Research**

The goal of this research is to see if a relationship exists between the acidity (pH) of a wound and bacterial contamination. If such a relationship exists, then pH measurement would lessen the time needed to find out the level of bacterial contamination, in the wound. Treatment could be started sooner.

**Your Rights**

It is important for you to know that:

- Your participation is entirely voluntary.
- You may decide not to take part or decide to quit the study at any time, without any penalty.
- You will be told about any new information or changes in the study that might affect your participation.

**PROCEDURES**

Your participation in the research will last for one regularly scheduled appointment

The following information will be taken from your medical record. Age, gender, race, current medications, and wound history and condition.

After standard treatment that you normally receive a disinfected material will be placed over the wound. A meter that measures acid levels will be touched to the surface of the wound in 4 to 5 locations depending on wound size. The slight pressure from the electrode may cause minor



HSC Docket # H- 9859  
discomfort. This is the experimental procedure.

Next, the wound will be swabbed in 1 to 5 locations depending on wound size, so that bacterial cultures may be grown to determine if the wound is contaminated. Depending on the condition of the wound minimal bleeding may occur. Care will be taken to choose locations that are not highly sensitive.

Finally, a digital image of the wound will be taken. The digital picture will let us associate the color and type of wound with the acid measurement.

The whole procedure should take 15 minutes.

### **RISKS**

There are no risks associated with this procedure, except for the possible discomfort of pressure from the meter.

The swabbing procedure may cause minimal bleeding.

Your condition will be watched closely during the study. If you have any serious reactions or problems, the treatment will be changed or stopped to protect your health.

### **BENEFITS**

There is no direct benefit to you from being in this study. However, your participation may help others with this condition in the future as a result of knowledge gained from the research.

### **REASONS YOU MIGHT BE WITHDRAWN FROM THE STUDY WITHOUT YOUR CONSENT**

You may be taken out of the research study if:  
The investigator decides that continuing in the study would be harmful to you.

### **COSTS**

There will be no additional cost to you from being in this research study. The medicines, clinic visits, and tests that are done for research purposes will be free. Any costs for the standard treatment of your condition will be billed to you or your health insurance.

### **CONFIDENTIALITY**

Your research records will be confidential to the extent possible by law. In all records of the study you will be identified by a code number and your name will be known only to the researchers. Your name will not be used in any reports or publications of this study. However, the study sponsor, and the U.S. Food and Drug Administration (FDA) may inspect your medical records that pertain to this research study.

HSC Docket # H- 9859

**YOUR PARTICIPATION IN THIS PROJECT IS ENTIRELY VOLUNTARY. YOU MAY WITHDRAW FROM THE STUDY AT ANY TIME.**

**THE QUALITY OF CARE YOU RECEIVE AT THIS HOSPITAL WILL NOT BE AFFECTED IN ANY WAY IF YOU DECIDE NOT TO PARTICIPATE OR IF YOU WITHDRAW FROM THE STUDY.**

#### **RESEARCH INJURY/COMPENSATION**

If you are injured or have any harmful effects as a direct result of your participation in this research, treatment will be made available to you at UMass/ Memorial Health Care (UM/MHC). If you have health care insurance, the costs associated with this treatment may be billed to your insurer. You will not have to pay any charges resulting from the harmful effect or injury that are not covered by your insurance. If you do not have insurance, you will not have to pay any charges resulting from the harmful effect or injury. This arrangement applies only when you receive medical care at UM/MHC. Only necessary medical treatment will be offered to you; you will not receive any additional compensation from UM/MHC. The fact that UM/MHC provides this treatment is not an admission by UM/MHC that it is responsible for the injury.

#### **QUESTIONS**

Please feel free to ask any questions you may have about the study or about your rights as a research subject. If other questions occur to you later, you may ask Dr. Ray Dunn, the principal investigator at 856-5280. If at any time during or after the study, you would like to discuss the study or your research rights with someone who is not associated with the research study, you may contact the Administrative Coordinator for the Committee for the Protection of Human Subjects in Research at UMMS. The telephone number is (508) 856-4261.

#### **CONSENT TO PARTICIPATE IN THE RESEARCH PROJECT**

**Title: Estimation of Wound Properties by pH measurement**

P.I. Name: Raymond Dunn, M.D.

Subject's Name:

The purpose and procedures of this research project and the predictable discomfort, risks, and benefits that might result have been explained to me. I have been told that unforeseen events may occur. I have had an opportunity to discuss this with the investigator and all of my questions have been answered. I agree to participate as a volunteer in this research project. I understand that I may end my participation at any time. I have been given a copy of this consent form.

HSC Docket # H- 9859

X \_\_\_\_\_ Date:  
Subject's signature

Subject's Representative if appropriate:

Name: \_\_\_\_\_ Relationship to Subject:  
(Print)

\_\_\_\_\_ Date:  
Representative's Signature

*Witness may be used at the P.I.'s discretion*

Name:  
(Print)

Witness Signature: \_\_\_\_\_ Date:

**INVESTIGATOR'S DECLARATION**

I have explained to the above-named subject the nature and purpose of the procedures described above and the foreseeable risks, discomforts, and benefits that may result. I have asked the subject if any questions have arisen regarding the procedures and have answered these questions to the best of my ability. I have considered and rejected alternative procedures for answering this research question.

I have communicated with Dr. \_\_\_\_\_ on \_\_\_\_\_ and in his/her opinion it is acceptable for this patient to participate in this study.

X \_\_\_\_\_ Date:  
P.I.'s Signature

## APPENDIX B

Patient Information Sheet

Patient Code:

Age:

Gender:

Race (optional):

---

Age of Wound:

Description of Wound – cause, type, appearance, treatment:

---

Electrode Number:

Calibration Characteristics: slope =                      intercept =

File name:

Number of points measured:

Notes about measurements – position, tissue appearance, problems:

## APPENDIX C

